



Vers. 2.0

Original Cutters / Frese Originali
Original Fräser / Fraises d'Origine
Fresas Originales / Fresas Originales





Dear Customer,
congratulation for choosing original Silca accessories.
Silca accessories are made exclusively with top quality innovative materials and each one is tested and carefully controlled.

Raw materials, dimensions, finishes, duration, resistance and packaging that protects the product and its quality are the primary characteristics of original Silca accessories.
Each model of Silca cutters is painstakingly tested and controlled in order to guarantee optimum operation of key-cutting machines and the highest precision cutting.

The Silca range of tracer points and cutters for key-cutting machines is one of the most complete and comprehensive available in the key-cutting field and is based specifically on long experience and special attention paid to the needs of specialist key cutters in the trade.

Every day work groups of specialists and engineers committed to research into product innovation subject our cutters and tracer points to continuous improvement and evolution regarding both materials and performance, in order to guarantee the best key-cutting results possible.

Silca S.p.A.

ITALIANO

Gentile Cliente, complimenti per aver scelto degli accessori originali Silca. I nostri accessori sono prodotti esclusivamente con materiali innovativi e di alta qualità ed ogni accessorio Silca è testato e accuratamente controllato. Materia prima, dimensioni, finiture, durata, resistenza e confezioni che garantiscono la qualità e conservazione del prodotto sono caratteristiche primarie degli accessori originali Silca. Ogni modello di fresa Silca è accuratamente testato e verificato al fine di garantire l'ottimale funzionamento delle macchine duplicatrici e la massima precisione ai risultati di duplicazione. La gamma tastatori e frese Silca per macchine duplicatrici è una tra le più ampie e ricca esistente nel settore della duplicazione chiavi e nasce specificatamente da un'esperienza di lunga data e da un'attenzione speciale alle esigenze dei Professionisti della duplicazione. Le nostre frese e i tastatori sono oggetto di continuo miglioramento ed evoluzione sia per quanto attiene i materiali che per le performance da parte di gruppi di lavoro di specialisti e tecnici che sono impegnati quotidianamente nella ricerca e nell'innovazione di prodotto per garantire sempre i migliori risultati nella duplicazione.

DEUTSCH

Sehr geehrter Kunde, wir gratulieren Ihnen zur Wahl der Silca Originalwerkzeuge. Unsere Werkzeuge werden ausschließlich aus innovativem und qualitativ hochwertigem Material hergestellt und jedes Zubehör wird sorgfältig getestet und geprüft. Rohmaterial, Abmessungen, Ausführungen, Lebensdauer, Widerstandsfähigkeit und Verpackungen, die die Qualität und Konservierung des Produkts gewährleisten, sind primäre Eigenschaften des Original-Zubehörs von Silca. Jedes Silca Fräsermodell wurde sorgfältig getestet und geprüft, um optimale Funktionstüchtigkeit der Schlüsselkopiermaschinen und höchste Präzision der Kopiererergebnisse zu gewährleisten. Die Produktreihe von Tastern und Fräsern von Silca für Schlüsselkopiermaschinen ist eine der derzeit vielfältigsten auf dem Schlüsselkopiersektor und das Ergebnis langjähriger Erfahrung und Berücksichtigung der Anforderungen des Schlüsselfachmanns. Unsere Fräser und Taster werden sowohl hinsichtlich Material als auch Leistung von einer Gruppe von Fachleuten und Technikern laufend weiter entwickelt, die sich täglich der Forschung und Innovation des Produkts widmen, um immer ausgezeichnete Kopiererergebnisse gewährleisten zu können.

FRANÇAIS

Cher Client, cher Client, merci d'avoir choisi nos accessoires originaux Silca. Nos accessoires sont fabriqués exclusivement avec des matériaux innovants et de haute qualité, et chaque accessoire Silca est testé et soigneusement contrôlé. Matières premières, dimensions, finitions, durée, résistance et conditionnement garantissent la qualité et la conservation de nos produits; telles sont les caractéristiques primaires de nos accessoires originaux Silca. Chaque modèle de fraise Silca est méticuleusement testé et vérifié afin de garantir le fonctionnement optimal de nos machines à reproduire les clés ainsi que la précision du résultat dans la duplication. La gamme des palpeurs et fraises Silca pour duplicatrices est une des plus amples et des plus riches existant dans le secteur de la reproduction de clés; elle est précisément issue d'une expérience de longue durée et d'une attention toute spéciale réservée aux exigences des Professionnels de la duplication. Nos fraises et palpeurs sont constamment améliorés et rénovés tant en ce qui concerne les matériaux que les performances grâce à nos groupes de spécialistes et de techniciens qui s'appliquent quotidiennement à faire progresser et à innover nos produits pour garantir en toute circonstance les meilleurs résultats dans la duplication.

ESPAÑOL

Estimado cliente, felicidades por haber elegido los accesorios originales Silca. Nuestros accesorios están fabricados exclusivamente con materiales innovadores y de alta calidad, y cada accesorio Silca está probado y controlado cuidadosamente. Las materias primas, las dimensiones, los acabados, la duración, la resistencia y elaboración que garantizan la calidad y la conservación del producto son características principales de los accesorios originales Silca. Cada modelo de fresa Silca está cuidadosamente probado y revisado con el fin de garantizar un funcionamiento óptimo de las máquinas duplicadoras y una máxima precisión en los resultados de la duplicación. La gama de palpadores y frezas Silca para máquinas duplicadoras es una de las más amplias y completas que hay en el sector de la duplicación de llaves, y se basa principalmente en una larga experiencia y en una atención especial a las exigencias de los profesionales de la duplicación. Nuestras frezas y palpadores son objeto de constante mejora y evolución, tanto en lo que se refiere a los materiales como a su rendimiento, por parte de especialistas y técnicos que cada día se dedican a la búsqueda e innovación de nuestros productos, y que consiguen garantizar resultados cada vez más mejores en la duplicación.

PORTUGUÊS

Prezado Cliente, congratulação por ter escolhido acessórios originais Silca. Os nossos acessórios são fabricados exclusivamente com materiais inovadores e de alta qualidade; cada acessório Silca é testado e controlado minuciosamente. Matéria-prima, dimensões, acabamentos, duração, resistência, embalagens que garantem a qualidade e a conservação do produto são características primárias dos acessórios originais Silca. Cada modelo de fresa Silca é cuidadosamente testado e verificado a fim de garantir o melhor funcionamento das máquinas duplicadoras e a máxima precisão nos resultados de duplicação. A gama de palpadores e frezas Silca para máquinas duplicadoras é uma entre as mais amplas e ricas existentes no sector da duplicação de chaves e nasce especificadamente de uma experiência demorada e de uma atenção especial para as exigências dos Profissionais da duplicação. As nossas frezas e os palpadores são objecto de contínuos melhoramentos e evolução seja a nível de materiais bem como de performances, por parte de equipas de trabalho especializadas e de técnicos, empenhados diariamente na pesquisa e na inovação dos produtos para garantir sempre os melhores resultados na duplicação.

SILCA S.p.A.



The main reason for the success of the Silca Group depends upon the fact that it is the only company in the world to have conceived key cutting as a complete system. The Silca Key System starts from the manufacturing and production of keys and key cutting machines up to the development of customised products based on customers' requirements.

Il principale fattore di successo del Gruppo Silca sta nell'essere stata l'unica azienda al mondo ad aver concepito la duplicazione come un sistema completo, un vero e proprio Silca Key System, che fluisce dalla produzione di chiavi a quella delle macchine duplicatrici, fino allo sviluppo di prodotti personalizzati sulla base delle necessità del singolo cliente.

Der Erfolg der Silca Gruppe liegt hauptsächlich darin begründet, dass wir das Schlüsselkopieren als komplettes System verstehen und anbieten, das sogenannte "Silca Key System". Dieses System beinhaltet die Produktion von Schlüsseln, Schlüsselfräsmaschinen wie auch die Entwicklung von Produkten, die auf die individuellen Wünsche jedes einzelnen Kunden abgestimmt werden.

Le principal facteur de succès du groupe Silca tient au fait qu'il a été la seule entreprise au monde à avoir conçu la duplication comme un système complet, un véritable Silca Key System, qui va de la production de clés à celle des machines duplicatrices, en passant par la réalisation de produits personnalisés sur la base des nécessités de chaque client.

El factor principal del éxito del Grupo Silca es haber sido la única empresa del mundo que ha concebido la duplicación como un sistema completo, un verdadero Silca Key System que abarca desde la producción de llaves y máquinas duplicadoras, hasta el desarrollo de productos personalizados según la necesidad de cada cliente.

O principal factor de sucesso do Grupo Silca é ter sido a única empresa no mundo a considerar a duplicação como um sistema completo, um verdadeiro Silca Key System, que abrange a produção de chaves e máquinas duplicadoras, até ao desenvolvimento de produtos personalizados de acordo com as necessidades de cada cliente.

Original Accessories and Spare Parts

Ricambi e accessori originali / Original Zubehör und Ersatzteile / Accessoires et Pièces de Rechange Originaux / Accesorios y Repuestos Originales / Acessórios e Peças de Reposição Originais



A complete range of accessories devised for the entire range of the key cutting machines ensures the easy duplication of all kind of keys.

We recommend Silca's original spare parts and accessories

Una gamma completa di accessori studiati per l'intera famiglia delle duplicatrici assicura la facile riproduzione di tutte le tipologie di chiavi.

Preferite ricambi e accessori originali Silca.

Ein vollständiges Angebot an Zubehör, das speziell für unsere Schlüsselfräsmaschinen entwickelt wurde, ermöglicht einfaches und sicheres Kopieren aller Schlüsselarten.

Wir empfehlen Original Silca-Ersatzteile und Zubehörartikel.

Une gamme complète d'accessoires étudiés pour toute la gamme des duplicatrices garantit la reproduction facile de toutes les typologies de clés.

Préférez les pièces de rechange et les accessoires originaux Silca.

Una gama completa de accesorios ideados para toda la gama de máquinas duplicadoras asegura la fácil reproducción de todos los tipos de llaves.

Elija recambios y accesorios originales Silca.

Uma gama completa de acessórios estudados para a inteira família das máquinas duplicadoras assegura a reprodução fácil de todos os tipos de chaves.

Prefira peças de reposição e acessórios originais Silca.

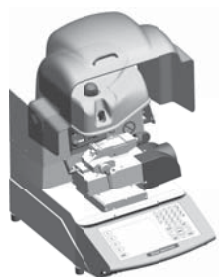

Key Cutting Machines

IT	Duplicatrici
DE	Schlüsselkopiermaschinen
FR	Machines à tailler les clés
ES	Duplicadoras
PT	Duplicadoras

Chapter	Page
---------	------

1

11-36



Double Angle Cutters

IT	Frese Prismatiche
DE	Prismen Fräser
FR	Fraises Isocèles
ES	Fresas Isósceles
PT	Fresas Isósceles

Chapter	Page
---------	------

2

37-42



Milling Slot Cutters

IT	Frese a Seghetto
DE	Schlitzfräser
FR	Fraises Scie
ES	Fresas Dentadas
PT	Fresas com Dentas

Chapter	Page
---------	------

3

43-48

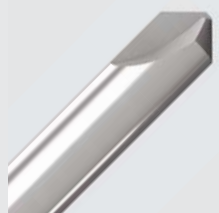

Cutters and Tracer Points for Electronic Key Cutting Machines

IT	Fresini e Tastatori per Duplicatrici Elettroniche
DE	Fräser und Taster für Elektronische Schlüsselkopiermaschine
FR	Fraises et Palpeurs pour Machines Électroniques
ES	Fresas y Palpadores para Duplicadoras Electrónicas
PT	Fresas e Palpadores para Duplicadoras Electrónicas

Chapter	Page
---------	------

4

49-62



Cutters and Tracer Points for Mechanic Key Cutting Machines

IT	Fresini e Tastatori per Duplicatrici Meccaniche
DE	Fräser und Taster für Mechanische Schlüsselkopiermaschine
FR	Fraises et Palpeurs pour Machines Mécaniques
ES	Fresas y Palpadores para Duplicadoras Mecánicas
PT	Fresas e Palpadores para Duplicadoras Mecánicas

Chapter	Page
---------	------

5

63-73

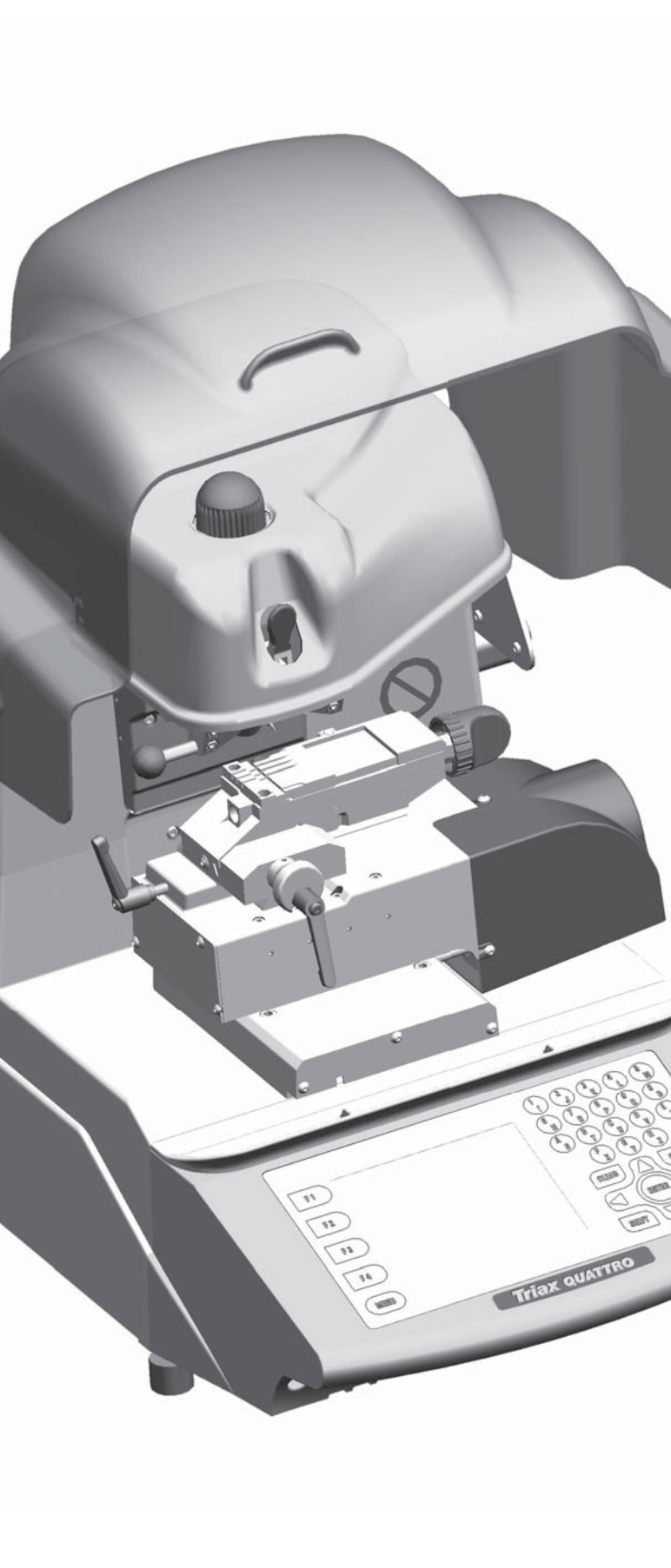

1

Key Cutting Machines

- IT Duplicatrici
- DE Schlüsselkopiermaschinen
- FR Machines à tailler les clés
- ES Duplicadoras
- PT Duplicadoras

Electronic Key Cutting Machines

Duplicatrici Elettroniche / Elektronische Schlüsselkopiermaschinen / Machines à Tailler les clés Électronique / Máquinas Duplicadoras Electrónicas
Máquinas Duplicadoras Electrónicas

Key Cutting Machines Duplicatrici Schlüsselkopiermaschinen Machines à tailler les clés Duplicadoras Duplicadora	Model Modello Modell Modél Modelo	Code Codice Kode Code Código Código	Standard / Optional	Page
IDEA	PL1.25	D726023ZB	standard	46
	PL1.25	D736154ZB	optional	45
	PL1.00	D710036ZB	optional	45
	PL1.50	D709696ZB	optional	45
	PL1.70	D723584ZB	optional	45
	PL1.90	D712527ZB	optional	45
	PL2.20	D723422ZB	optional	45
	PL2.40	D714465ZB	optional	45
LEONARDO	U01	D716549ZB	standard	41
PRIMA LASER	PL1.00	D710036ZB	standard	45
	PL1.6	D730435ZB	optional	46
	PL1.65	D737787ZB	optional	46
	PL1.8	D735331ZB	optional	46
	PL1.25	D726023ZB	optional	46
	PL1.25	D736154ZB	optional	45
	PL1.50	D709696ZB	optional	45
	PL1.70	D723584ZB	optional	45
	PL1.90	D712527ZB	optional	45
	PL2.5	D738936ZB	optional	46
	PL2.00	D723621ZB	optional	46

Key Cutting Machines Duplicatrici Schlüsselkopiermaschinen Machines à tailler les clés Duplicadoras Duplicadora	Model Modello Modell Modél Modelo	Code Codice Kode Code Código Código	Standard / Optional	Page
PRIMA LASER	PL2.20	D723422ZB	optional	45
	PL2.40	D714465ZB	optional	45
PROTECH	W151	D737951ZB	optional	52
	W156	D740515ZB	optional	52
	W157	D740516ZB	optional	52
	W159	D741034ZB	optional	57
	W299	D736503ZB	optional	53
	W305	D738391ZB	optional	55
	W308	D738765ZB	optional	53
	W311	D741395ZB	optional	59
	W312	D741396ZB	optional	55
	W313	D741452ZB	optional	59

Electronic Key Cutting Machines

Duplicatrici Elettroniche / Elektronische Schlüsselkopiermaschinen / Machines à Tailler les clés Électronique / Máquinas Duplicadoras Electrónicas
Máquinas Duplicadoras Electrónicas

Key Cutting Machines Duplicatrici Schlüsselkopiermaschinen Machines à tailler les clés Duplicadoras Duplicadora	Model Modello Modell Modél Modelo Modelo	Code Codice Kode Code Código Código	Standard / Optional	Page
QUATTROCODE	H101	D708742ZB	standard	55
	H102	D708743ZB	optional	53
	H103	D709115ZB	optional	53
	H104	D709116ZB	optional	53
	H105	D708740ZB	optional	53
	H106	D709117ZB	optional	53
	H107	D708741ZB	optional	53
	H108	D709118ZB	optional	54
	H109	D709119ZB	optional	54
	H110	D709120ZB	optional	59
	H110 (MAT X85)	D710306ZB	optional	59
	H111	D709121ZB	optional	59
	H111 (MAT. X85)	D710307ZB	optional	59
	H138	D722573ZB	optional	54
	H254	D717602ZB	optional	60
	W101	D709238ZB	optional	54
	W101T- LEXUS	D714471ZB	optional	54
	W102	D709239ZB	optional	51
	W103	D709240ZB	optional	51
	W104	D709241ZB	optional	51

Key Cutting Machines Duplicatrici Schlüsselkopiermaschinen Machines à tailler les clés Duplicadoras Duplicadora	Model Modello Modell Modél Modelo Modelo	Code Codice Kode Code Código Código	Standard / Optional	Page
QUATTROCODE	W105	D709242ZB	optional	51
	W106	D709243ZB	optional	51
	W107	D709244ZB	optional	51
	W108	D709245ZB	optional	51
	W109	D709246ZB	optional	51
	W110	D709247ZB	optional	56
	W111	D709248ZB	optional	56
	W112	D709249ZB	optional	56
	W113	D709250ZB	optional	51
	W114	D709482ZB	optional	54
	W115	D709512ZB	optional	56
	W116	D709792ZB	optional	51
	W117	D710042ZB	optional	56
	W118	D710018ZB	optional	51
	W119	D710158ZB	optional	51
	W120	D710162ZB	optional	56
	W121	D710177ZB	optional	56
	W122	D710424ZB	optional	51
	W123	D710438ZB	optional	51
	W124	D710569ZB	optional	56

Electronic Key Cutting Machines

Duplicatrici Elettroniche / Elektronische Schlüsselkopiermaschinen / Machines à Tailler les clés Électronique / Máquinas Duplicadoras Electrónicas
Máquinas Duplicadoras Electrónicas

Key Cutting Machines Duplicatrici Schlüsselkopiermaschinen Machines à tailler les clés Duplicadoras Duplicadora	Model Modello Modell Modél Modelo Modelo	Code Codice Kode Code Código Código	Standard / Optional	Page
QUATTROCODE	W125	D710659ZB	optional	56
	W126	D711129ZB	optional	56
	W127	D711127ZB	optional	56
	W128	D711124ZB	optional	56
	W129	D711604ZB	optional	54
	W130	D712391ZB	optional	51
	W131	D712633ZB	optional	54
	W132	D712737ZB	optional	56
	W133	D715168ZB	optional	54
	W134	D723062ZB	optional	54
	W135	D721004ZB	optional	56
	W136	D722178ZB	optional	56
	W137	D722502ZB	optional	56
	W138	D722580ZB	optional	51
	W139	D724961ZB	optional	56
	W140	D727335ZB	optional	51
	W142	D728783ZB	optional	51
	W143	D729491ZB	optional	56
	W144	D729493ZB	optional	56
	W145	D729494ZB	optional	57

Key Cutting Machines Duplicatrici Schlüsselkopiermaschinen Machines à tailler les clés Duplicadoras Duplicadora	Model Modello Modell Modél Modelo Modelo	Code Codice Kode Code Código Código	Standard / Optional	Page
QUATTROCODE	W147	D734848ZB	optional	52
	W148	D735439ZB	optional	54
	W149	D735457ZB	optional	57
	W150	D736541ZB	optional	57
	W152	D738003ZB	optional	52
	W153	D738415ZB	optional	57
	W154	D738523ZB	optional	57
	W201	D709361ZB	optional	57
	W202	D709362ZB	optional	54
	W203	D709643ZB	optional	52
	W204	D709642ZB	optional	57
	W205	D710776ZB	optional	52
	W206	D710777ZB	optional	52
	W207	D710838ZB	optional	57
	W208	D710963ZB	optional	57
	W209	D711009ZB	optional	54
	W210	D711023ZB	optional	57
	W211	D711136ZB	optional	57
	W212	D711229ZB	optional	57
	W213	D711542ZB	optional	57

Electronic Key Cutting Machines

Duplicatrici Elettroniche / Elektronische Schlüsselkopiermaschinen / Machines à Tailler les clés Électronique / Máquinas Duplicadoras Electrónicas
Máquinas Duplicadoras Electrónicas

Key Cutting Machines Duplicatrici Schlüsselkopiermaschinen Machines à tailler les clés Duplicadoras Duplicadora	Model Modello Modell Modél Modelo Modelo	Code Codice Kode Code Duplicadora Código Código	Standard / Optional	Page
QUATTROCODE	W214	D711554ZB	optional	57
	W215	D711605ZB	optional	54
	W216	D711606ZB	optional	55
	W217	D711629ZB	optional	57
	W218	D712080ZB	optional	52
	W219	D712374ZB	optional	55
	W220	D712480ZB	optional	55
	W221	D712713ZB	optional	57
	W222	D712789ZB	optional	52
	W223	D714984ZB	optional	52
	W224	D712653ZB	optional	52
	W225	D712802ZB	optional	57
	W226	D712682ZB	optional	57
	W227	D712683ZB	optional	57
	W228	D712684ZB	optional	57
	W231	D712921ZB	optional	58
	W232	D714985ZB	optional	52
	W233	D714986ZB	optional	52
	W234	D713999ZB	optional	52
	W236	D714139ZB	optional	52

Key Cutting Machines Duplicatrici Schlüsselkopiermaschinen Machines à tailler les clés Duplicadoras Duplicadora	Model Modello Modell Modél Modelo Modelo	Code Codice Kode Code Duplicadora Código Código	Standard / Optional	Page
QUATTROCODE	W237	D714140ZB	optional	52
	W238	D714285ZB	optional	58
	W239	D713218ZB	optional	58
	W240	D713286ZB	optional	52
	W241	D713287ZB	optional	52
	W242	D713572ZB	optional	58
	W243	D713573ZB	optional	58
	W244	D713574ZB	optional	58
	W245	D713575ZB	optional	58
	W247	D713830ZB	optional	58
	W248	D714236ZB	optional	55
	W249	D714440ZB	optional	55
	W251	D714647ZB	optional	58
	W252	D715028ZB	optional	55
	W253	D716871ZB	optional	58
	W255	D717065ZB	optional	58
	W258	D717531ZB	optional	58
	W259	D717546ZB	optional	58
	W260	D717658ZB	optional	55
	W261	D721116ZB	optional	58

Electronic Key Cutting Machines

Duplicatrici Elettroniche / Elektronische Schlüsselkopiermaschinen / Machines à Tailler les clés Électronique / Máquinas Duplicadoras Electrónicas

Máquinas Duplicadoras Electrónicas

Key Cutting Machines Duplicatrici Schlüsselkopiermaschinen Machines à tailler les clés Duplicadoras Duplicadora	Model Modelo Modell Modél Modelo Modelo	Code Codice Code Code Código Código	Standard / Optional	Page
QUATTROCODE	W262	D721670ZB	optional	52
	W265	D722000ZB	optional	58
	W267	D722738ZB	optional	58
	W268	D717483ZB	optional	55
	W269	D724570ZB	optional	53
	W270	D724672ZB	optional	58
	W271	D725076ZB	optional	58
	W272	D725622ZB	optional	58
	W273	D726008ZB	optional	58
	W274	D726050ZB	optional	53
	W275	D726404ZB	optional	59
	W277	D728170ZB	optional	59
	W278	D728514ZB	optional	59
	W279	D728856ZB	optional	59
	W280	D728857ZB	optional	59
	W281	D728858ZB	optional	55
	W282	D729141ZB	optional	59
	W283	D729319ZB	optional	53
	W284	D729320ZB	optional	53
	W285	D729942ZB	optional	55

Key Cutting Machines Duplicatrici Schlüsselkopiermaschinen Machines à tailler les clés Duplicadoras Duplicadora	Model Modelo Modell Modél Modelo Modelo	Code Codice Code Code Código Código	Standard / Optional	Page
QUATTROCODE	W286	D730617ZB	optional	53
	W287	D731048ZB	optional	59
	W288	D731309ZB	optional	55
	W289	D731447ZB	optional	53
	W290	D731956ZB	optional	53
	W291	D732180ZB	optional	59
	W292	D734217ZB	optional	55
	W293	D734544ZB	optional	59
	W294	D734601ZB	optional	59
	W295	D734579ZB	optional	59
	W296	D735973ZB	optional	59
	W297	D735955ZB	optional	53
	W298	D737492ZB	optional	59
	W300	D736794ZB	optional	59
	W301	D737183ZB	optional	53
	W302	D737688ZB	optional	59
	W303	D737705ZB	optional	55
	W304	D737706ZB	optional	53
	W306	D738450ZB	optional	59
	W307	D738677ZB	optional	53

Electronic Key Cutting Machines

Duplicatrici Elettroniche / Elektronische Schlüsselkopiermaschinen / Machines à Tailler les clés Électronique / Máquinas Duplicadoras Electrónicas
Máquinas Duplicadoras Electrónicas

Key Cutting Machines Duplicatrici Schlüsselkopiermaschinen Machines à tailler les clés Duplicadoras Duplicadora	Model Modello Modell Modél Modelo	Code Codice Kode Code Código Código	Standard / Optional	Page
QUATTROCODE	W310	D740970ZB	optional	59
	W314	D741725ZB	optional	60
TRIAx QUATTRO	W101	D709238ZB	standard	54
	W146-ENGR.	D734267ZB	standard	51
	W500-UNIV.	D738590ZB	standard	53
	H101	D708742ZB	optional	55
	H102	D708743ZB	optional	53
	H103	D709115ZB	optional	53
	H104	D709116ZB	optional	53
	H105	D708740ZB	optional	53
	H106	D709117ZB	optional	53
	H107	D708741ZB	optional	53
	H108	D709118ZB	optional	54
	H109	D709119ZB	optional	54
	H110	D709120ZB	optional	59
	H110 (MAT. X85)	D710306ZB	optional	59
	H111	D709121ZB	optional	59
H111 (MAT. X85)	D710307ZB	optional	59	
H112	D709122ZB	optional	60	

Key Cutting Machines Duplicatrici Schlüsselkopiermaschinen Machines à tailler les clés Duplicadoras Duplicadora	Model Modello Modell Modél Modelo	Code Codice Kode Code Código Código	Standard / Optional	Page
TRIAx QUATTRO	H112 (MAT. X85)	D710308ZB	optional	60
	H113	D709123ZB	optional	54
	H114	D709481ZB	optional	55
	H115	D709511ZB	optional	60
	H117	D709974ZB	optional	60
	H118	D710017ZB	optional	54
	H119	D710157ZB	optional	54
	H120	D710161ZB	optional	54
	H126	D711128ZB	optional	60
	H127	D711126ZB	optional	60
	H128	D711125ZB	optional	60
	H131	D712438ZB	optional	55
	H138	D722573ZB	optional	54
	H254	D717602ZB	optional	60
	W101T-LEXUS	D714471ZB	optional	54
	W102	D709239ZB	optional	51
	W103	D709240ZB	optional	51
	W104	D709241ZB	optional	51
	W105	D709242ZB	optional	51
	W106	D709243ZB	optional	51

Electronic Key Cutting Machines

Duplicatrici Elettroniche / Elektronische Schlüsselkopiermaschinen / Machines à Tailler les clés Électronique / Máquinas Duplicadoras Electrónicas

Máquinas Duplicadoras Electrónicas

Key Cutting Machines Duplicatrici Schlüsselkopiermaschinen Machines à tailler les clés Duplicadoras Duplicadora	Model Modelo Modell Modél Modelo Modelo	Code Codice Code Code Código Código	Standard / Optional	Page
TRIAx QUATTRO	W107	D709244ZB	optional	51
	W108	D709245ZB	optional	51
	W109	D709246ZB	optional	51
	W110	D709247ZB	optional	56
	W111	D709248ZB	optional	56
	W112	D709249ZB	optional	56
	W113	D709250ZB	optional	51
	W114	D709482ZB	optional	54
	W115	D709512ZB	optional	56
	W116	D709792ZB	optional	51
	W117	D710042ZB	optional	56
	W118	D710018ZB	optional	51
	W119	D710158ZB	optional	51
	W120	D710162ZB	optional	56
	W121	D710177ZB	optional	56
	W122	D710424ZB	optional	51
	W123	D710438ZB	optional	51
	W124	D710569ZB	optional	56
	W125	D710659ZB	optional	56
	W126	D711129ZB	optional	56

Key Cutting Machines Duplicatrici Schlüsselkopiermaschinen Machines à tailler les clés Duplicadoras Duplicadora	Model Modelo Modell Modél Modelo Modelo	Code Codice Code Code Código Código	Standard / Optional	Page
TRIAx QUATTRO	W127	D711127ZB	optional	56
	W128	D711124ZB	optional	56
	W129	D711604ZB	optional	54
	W130	D712391ZB	optional	51
	W131	D712633ZB	optional	54
	W132	D712737ZB	optional	56
	W133	D715168ZB	optional	54
	W134	D723062ZB	optional	54
	W135	D721004ZB	optional	56
	W136	D722178ZB	optional	56
	W137	D722502ZB	optional	56
	W138	D722580ZB	optional	51
	W139	D724961ZB	optional	56
	W140	D727335ZB	optional	51
	W142	D728783ZB	optional	51
	W143	D729491ZB	optional	56
	W144	D729493ZB	optional	56
	W145	D729494ZB	optional	57
	W147	D734848ZB	optional	52
	W148	D735439ZB	optional	54

Electronic Key Cutting Machines

Duplicatrici Elettroniche / Elektronische Schlüsselkopiermaschinen / Machines à Tailler les clés Électronique / Máquinas Duplicadoras Electrónicas
Máquinas Duplicadoras Electrónicas

Key Cutting Machines Duplicatrici Schlüsselkopiermaschinen Machines à tailler les clés Duplicadoras Duplicadora	Model Modello Modell Modél Modelo Modelo	Code Codice Kode Code Código Código	Standard / Optional	Page
TRIAx QUATTRO	W149	D735457ZB	optional	57
	W150	D736541ZB	optional	57
	W152	D738003ZB	optional	52
	W153	D738415ZB	optional	57
	W154	D738523ZB	optional	57
	W201	D709361ZB	optional	57
	W202	D709362ZB	optional	54
	W203	D709643ZB	optional	52
	W204	D709642ZB	optional	57
	W205	D710776ZB	optional	52
	W206	D710777ZB	optional	52
	W207	D710838ZB	optional	57
	W208	D710963ZB	optional	57
	W209	D711009ZB	optional	54
	W210	D711023ZB	optional	57
	W211	D711136ZB	optional	57
	W212	D711229ZB	optional	57
	W213	D711542ZB	optional	57
	W214	D711554ZB	optional	57
	W215	D711605ZB	optional	54

Key Cutting Machines Duplicatrici Schlüsselkopiermaschinen Machines à tailler les clés Duplicadoras Duplicadora	Model Modello Modell Modél Modelo Modelo	Code Codice Kode Code Código Código	Standard / Optional	Page
TRIAx QUATTRO	W216	D711606ZB	optional	55
	W217	D711629ZB	optional	57
	W218	D712080ZB	optional	52
	W219	D712374ZB	optional	55
	W220	D712480ZB	optional	55
	W221	D712713ZB	optional	57
	W222	D712789ZB	optional	52
	W223	D714984ZB	optional	52
	W224	D712653ZB	optional	52
	W225	D712802ZB	optional	57
	W226	D712682ZB	optional	57
	W227	D712683ZB	optional	57
	W228	D712684ZB	optional	57
	W231	D712921ZB	optional	58
	W232	D714985ZB	optional	52
	W233	D714986ZB	optional	52
	W234	D713999ZB	optional	52
	W236	D714139ZB	optional	52
	W237	D714140ZB	optional	52
	W238	D714285ZB	optional	58

Electronic Key Cutting Machines

Duplicatrici Elettroniche / Elektronische Schlüsselkopiermaschinen / Machines à Tailler les clés Électronique / Máquinas Duplicadoras Electrónicas

Máquinas Duplicadoras Electrónicas

Key Cutting Machines Duplicatrici Schlüsselkopiermaschinen Machines à tailler les clés Duplicadoras Duplicadora	Model Modelo Modell Modél Modelo	Code Codice Kode Code Código Código	Standard / Optional	Page
TRIAx QUATTRO	W239	D713218ZB	optional	58
	W240	D713286ZB	optional	52
	W241	D713287ZB	optional	52
	W242	D713572ZB	optional	58
	W243	D713573ZB	optional	58
	W244	D713574ZB	optional	58
	W245	D713575ZB	optional	58
	W247	D713830ZB	optional	58
	W248	D714236ZB	optional	55
	W249	D714440ZB	optional	55
	W251	D714647ZB	optional	58
	W252	D715028ZB	optional	55
	W253	D716871ZB	optional	58
	W255	D717065ZB	optional	58
	W258	D717531ZB	optional	58
	W259	D717546ZB	optional	58
	W260	D717658ZB	optional	55
	W261	D721116ZB	optional	58
	W262	D721670ZB	optional	52
	W265	D722000ZB	optional	58

Key Cutting Machines Duplicatrici Schlüsselkopiermaschinen Machines à tailler les clés Duplicadoras Duplicadora	Model Modelo Modell Modél Modelo	Code Codice Kode Code Código Código	Standard / Optional	Page
TRIAx QUATTRO	W267	D722738ZB	optional	58
	W268	D717483ZB	optional	55
	W269	D724570ZB	optional	53
	W270	D724672ZB	optional	58
	W271	D725076ZB	optional	58
	W272	D725622ZB	optional	58
	W273	D726008ZB	optional	58
	W274	D726050ZB	optional	53
	W275	D726404ZB	optional	59
	W277	D728170ZB	optional	59
	W278	D728514ZB	optional	59
	W279	D728856ZB	optional	59
	W280	D728857ZB	optional	59
	W281	D728858ZB	optional	55
	W282	D729141ZB	optional	59
	W283	D729319ZB	optional	53
	W284	D729320ZB	optional	53
	W285	D729942ZB	optional	55
	W286	D730617ZB	optional	53
	W287	D731048ZB	optional	59

Electronic Key Cutting Machines

Duplicatrici Elettroniche / Elektronische Schlüsselkopiermaschinen / Machines à Tailler les clés Électronique / Máquinas Duplicadoras Electrónicas
Máquinas Duplicadoras Electrónicas

Key Cutting Machines Duplicatrici Schlüsselkopiermaschinen Machines à tailler les clés Duplicadoras Duplicadora	Model Modello Modell Modél Modelo Modelo	Code Codice Kode Code Código Código	Standard / Optional	Page
TRIAX QUATTRO	W288	D731309ZB	optional	55
	W289	D731447ZB	optional	53
	W290	D731956ZB	optional	53
	W291	D732180ZB	optional	59
	W292	D734217ZB	optional	55
	W293	D734544ZB	optional	59
	W294	D734601ZB	optional	59
	W295	D734579ZB	optional	59
	W296	D735973ZB	optional	59
	W297	D735955ZB	optional	53
	W298	D737492ZB	optional	59
	W300	D736794ZB	optional	59
	W301	D737183ZB	optional	53
	W302	D737688ZB	optional	59
	W303	D737705ZB	optional	55
	W304	D737706ZB	optional	53
	W306	D738450ZB	optional	59
	W307	D738677ZB	optional	53
W310	D740970ZB	optional	59	
W314	D741725ZB	optional	60	

Key Cutting Machines Duplicatrici Schlüsselkopiermaschinen Machines à tailler les clés Duplicadoras Duplicadora	Model Modello Modell Modél Modelo Modelo	Code Codice Kode Code Código Código	Standard / Optional	Page
TRIAX 2	W146- ENGR.	D734267ZB	optional	51
TRIAX-e.code	H101	D708742ZB	standard	55
	H102	D708743ZB	optional	53
	H103	D709115ZB	optional	53
	H104	D709116ZB	optional	53
	H105	D708740ZB	optional	53
	H106	D709117ZB	optional	53
	H107	D708741ZB	optional	53
	H108	D709118ZB	optional	54
	H109	D709119ZB	optional	54
	H110	D709120ZB	optional	59
	H110 (MAT. X85)	D710306ZB	optional	59
	H111	D709121ZB	optional	59
	H111 (MAT. X85)	D710307ZB	optional	59
	H112	D709122ZB	optional	60
	H112 (MAT. X85)	D710308ZB	optional	60
	H113	D709123ZB	optional	54
	H114	D709481ZB	optional	55
H115	D709511ZB	optional	60	
H117	D709974ZB	optional	60	

Electronic Key Cutting Machines

Duplicatrici Elettroniche / Elektronische Schlüsselkopiermaschinen / Machines à Tailler les clés Électronique / Máquinas Duplicadoras Electrónicas

Máquinas Duplicadoras Electrónicas

Key Cutting Machines Duplicatrici Schlüsselkopiermaschinen Machines à tailler les clés Duplicadoras Duplicadora	Model Modelo Modell Modél Modelo Modelo	Code Codice Kode Code Código Código	Standard / Optional	Page
TRIAX-e.code	H118	D710017ZB	optional	54
	H119	D710157ZB	optional	54
	H120	D710161ZB	optional	54
	H126	D711128ZB	optional	60
	H127	D711126ZB	optional	60
	H128	D711125ZB	optional	60
	H131	D712438ZB	optional	55
	H138	D722573ZB	optional	54
	H254	D717602ZB	optional	60
	W101T-LEXUS	D709238ZB	optional	54
	W101	D714471ZB	optional	54
	W102	D709239ZB	optional	51
	W103	D709240ZB	optional	51
	W104	D709241ZB	optional	51
	W105	D709242ZB	optional	51
	W106	D709243ZB	optional	51
	W107	D709244ZB	optional	51
	W108	D709245ZB	optional	51
	W109	D709246ZB	optional	51
	W110	D709247ZB	optional	56

Key Cutting Machines Duplicatrici Schlüsselkopiermaschinen Machines à tailler les clés Duplicadoras Duplicadora	Model Modelo Modell Modél Modelo Modelo	Code Codice Kode Code Código Código	Standard / Optional	Page
TRIAX-e.code	W111	D709248ZB	optional	56
	W112	D709249ZB	optional	56
	W113	D709250ZB	optional	51
	W114	D709482ZB	optional	54
	W115	D709512ZB	optional	56
	W116	D709792ZB	optional	51
	W117	D710042ZB	optional	56
	W118	D710018ZB	optional	51
	W119	D710158ZB	optional	51
	W120	D710162ZB	optional	56
	W121	D710177ZB	optional	56
	W122	D710424ZB	optional	51
	W123	D710438ZB	optional	51
	W124	D710569ZB	optional	56
	W125	D710659ZB	optional	56
	W126	D711129ZB	optional	56
	W127	D711127ZB	optional	56
	W128	D711124ZB	optional	56
	W129	D711604ZB	optional	54
	W130	D712391ZB	optional	51

Electronic Key Cutting Machines

Duplicatrici Elettroniche / Elektronische Schlüsselkopiermaschinen / Machines à Tailler les clés Électronique / Máquinas Duplicadoras Electrónicas
Máquinas Duplicadoras Electrónicas

Key Cutting Machines Duplicatrici Schlüsselkopiermaschinen Machines à tailler les clés Duplicadoras Duplicadora	Model Modello Modell Modél Modelo Modelo	Code Codice Kode Code Código Código	Standard / Optional	Page
TRIAX-e.code	W131	D712633ZB	optional	54
	W132	D712737ZB	optional	56
	W133	D715168ZB	optional	54
	W134	D723062ZB	optional	54
	W135	D721004ZB	optional	56
	W136	D722178ZB	optional	56
	W137	D722502ZB	optional	56
	W138	D722580ZB	optional	51
	W139	D724961ZB	optional	56
	W140	D727335ZB	optional	51
	W142	D728783ZB	optional	51
	W143	D729491ZB	optional	56
	W144	D729493ZB	optional	56
	W145	D729494ZB	optional	57
	W147	D734848ZB	optional	52
	W148	D735439ZB	optional	54
	W149	D735457ZB	optional	57
	W150	D736541ZB	optional	57
	W152	D738003ZB	optional	52
	W153	D738415ZB	optional	57

Key Cutting Machines Duplicatrici Schlüsselkopiermaschinen Machines à tailler les clés Duplicadoras Duplicadora	Model Modello Modell Modél Modelo Modelo	Code Codice Kode Code Código Código	Standard / Optional	Page
TRIAX-e.code	W154	D738523ZB	optional	57
	W201	D709361ZB	optional	57
	W202	D709362ZB	optional	54
	W203	D709643ZB	optional	52
	W204	D709642ZB	optional	57
	W205	D710776ZB	optional	52
	W206	D710777ZB	optional	52
	W207	D710838ZB	optional	57
	W208	D710963ZB	optional	57
	W209	D711009ZB	optional	54
	W210	D711023ZB	optional	57
	W211	D711136ZB	optional	57
	W212	D711229ZB	optional	57
	W213	D711542ZB	optional	57
	W214	D711554ZB	optional	57
	W215	D711605ZB	optional	54
	W216	D711606ZB	optional	55
	W217	D711629ZB	optional	57
	W218	D712080ZB	optional	52
	W219	D712374ZB	optional	55

Electronic Key Cutting Machines

Duplicatrici Elettroniche / Elektronische Schlüsselkopiermaschinen / Machines à Tailler les clés Électronique / Máquinas Duplicadoras Electrónicas
Máquinas Duplicadoras Electrónicas

Key Cutting Machines Duplicatrici Schlüsselkopiermaschinen Machines à tailler les clés Duplicadoras Duplicadora	Model Modelo Modell Modél Modelo	Code Codice Kode Code Código Código	Standard / Optional	Page
TRIAX-e.code	W220	D712480ZB	optional	55
	W221	D712713ZB	optional	57
	W222	D712789ZB	optional	52
	W223	D714984ZB	optional	52
	W224	D712653ZB	optional	52
	W225	D712802ZB	optional	57
	W226	D712682ZB	optional	57
	W227	D712683ZB	optional	57
	W228	D712684ZB	optional	57
	W231	D712921ZB	optional	58
	W232	D714985ZB	optional	52
	W233	D714986ZB	optional	52
	W234	D713999ZB	optional	52
	W236	D714139ZB	optional	52
	W237	D714140ZB	optional	52
	W238	D714285ZB	optional	58
	W239	D713218ZB	optional	58
	W240	D713286ZB	optional	52
	W241	D713287ZB	optional	52
	W242	D713572ZB	optional	58

Key Cutting Machines Duplicatrici Schlüsselkopiermaschinen Machines à tailler les clés Duplicadoras Duplicadora	Model Modelo Modell Modél Modelo	Code Codice Kode Code Código Código	Standard / Optional	Page
TRIAX-e.code	W243	D713573ZB	optional	58
	W244	D713574ZB	optional	58
	W245	D713575ZB	optional	58
	W247	D713830ZB	optional	58
	W248	D714236ZB	optional	55
	W249	D714440ZB	optional	55
	W251	D714647ZB	optional	58
	W252	D715028ZB	optional	55
	W253	D716871ZB	optional	58
	W255	D717065ZB	optional	58
	W258	D717531ZB	optional	58
	W259	D717546ZB	optional	58
	W260	D717658ZB	optional	55
	W261	D721116ZB	optional	58
	W262	D721670ZB	optional	52
	W265	D722000ZB	optional	58
	W267	D722738ZB	optional	58
	W268	D717483ZB	optional	55
	W269	D724570ZB	optional	53
	W270	D724672ZB	optional	58

Electronic Key Cutting Machines

Duplicatrici Elettroniche / Elektronische Schlüsselkopiermaschinen / Machines à Tailler les clés Électronique / Máquinas Duplicadoras Electrónicas
Máquinas Duplicadoras Electrónicas

Key Cutting Machines Duplicatrici Schlüsselkopiermaschinen Machines à tailler les clés Duplicadoras Duplicadora	Model Modello Modell Modél Modelo Modelo	Code Codice Kode Code Código Código	Standard / Optional	Page
TRIAX-e.code	W271	D725076ZB	optional	58
	W272	D725622ZB	optional	58
	W273	D726008ZB	optional	58
	W274	D726050ZB	optional	53
	W275	D726404ZB	optional	59
	W277	D728170ZB	optional	59
	W278	D728514ZB	optional	59
	W279	D728856ZB	optional	59
	W280	D728857ZB	optional	59
	W281	D728858ZB	optional	55
	W282	D729141ZB	optional	59
	W283	D729319ZB	optional	53
	W284	D729320ZB	optional	53
	W285	D729942ZB	optional	55
	W286	D730617ZB	optional	53
	W287	D731048ZB	optional	59
	W288	D731309ZB	optional	55
	W289	D731447ZB	optional	53
	W290	D731956ZB	optional	53
	W291	D732180ZB	optional	59

Key Cutting Machines Duplicatrici Schlüsselkopiermaschinen Machines à tailler les clés Duplicadoras Duplicadora	Model Modello Modell Modél Modelo Modelo	Code Codice Kode Code Código Código	Standard / Optional	Page
TRIAX-e.code	W292	D734217ZB	optional	55
	W293	D734544ZB	optional	59
	W294	D734601ZB	optional	59
	W295	D734579ZB	optional	59
	W296	D735973ZB	optional	59
	W297	D735955ZB	optional	53
	W298	D737492ZB	optional	59
	W300	D736794ZB	optional	59
	W301	D737183ZB	optional	53
	W302	D737688ZB	optional	59
	W303	D737705ZB	optional	55
	W304	D737706ZB	optional	53
	W306	D738450ZB	optional	59
	W307	D738677ZB	optional	53
	W310	D740970ZB	optional	59
	W314	D741725ZB	optional	60

Electronic Key Cutting Machines

Duplicatrici Elettroniche / Elektronische Schlüsselkopiermaschinen / Machines à Tailler les clés Électronique / Máquinas Duplicadoras Electrónicas
Máquinas Duplicadoras Electrónicas

Key Cutting Machines Duplicatrici Schlüsselkopiermaschinen Machines à tailler les clés Duplicadoras Duplicadora	Model Modelo Modell Modél Modelo Modelo	Code Codice Code Code Código Código	Standard / Optional	Page
ULTRACODE	U01	D716549ZB	standard	41
	02	D702845ZB	optional	39
	03	D702846ZB	optional	39
	04	D702847ZB	optional	39
	05	D702837ZB	optional	46
	06	D705040ZB	optional	46
	07	D705689ZB	optional	39
	05W	D705633ZB	optional	47
	06W	D706128ZB	optional	47
	A2	D702221ZB	optional	39
	A3	D702222ZB	optional	39
	A4	D705691ZB	optional	39
	CW1011	D702855ZB	optional	39
	CW1012	D702851ZB	optional	39
	CW1014MC	D702853ZB	optional	39
	CW20FM	D702854ZB	optional	39
	D1	D705634ZB	optional	39
	DK2	D702849ZB	optional	39
	GB1	D705690ZB	optional	47
	P24	D713055ZB	optional	40

Key Cutting Machines Duplicatrici Schlüsselkopiermaschinen Machines à tailler les clés Duplicadoras Duplicadora	Model Modelo Modell Modél Modelo Modelo	Code Codice Code Code Código Código	Standard / Optional	Page	
ULTRACODE	P26	D713125ZB	optional	40	
	P27	D713126ZB	optional	40	
	P37	D727882ZB	optional	41	
	S1	D700747ZB	optional	41	
	S3	D706199ZB	optional	41	
	U02W	D706249ZB	optional	41	
	U05W	D706731ZB	optional	41	
	U07W	D709224ZB	optional	41	
	U08W	D709225ZB	optional	41	
	UNOCODE	U01W	D734910ZB	standard	41
		02	D702845ZB	optional	39
		03	D702846ZB	optional	39
04		D702847ZB	optional	39	
05		D702837ZB	optional	46	
06		D705040ZB	optional	46	
07		D705689ZB	optional	39	
05W		D705633ZB	optional	47	
06W		D706128ZB	optional	47	
A2		D702221ZB	optional	39	
A3	D702222ZB	optional	39		

Electronic Key Cutting Machines

Duplicatrici Elettroniche / Elektronische Schlüsselkopiermaschinen / Machines à Tailler les clés Électronique / Máquinas Duplicadoras Electrónicas
Máquinas Duplicadoras Electrónicas

Key Cutting Machines Duplicatrici Schlüsselkopiermaschinen Machines à tailler les clés Duplicadoras Duplicadora	Model Modello Modell Modél Modelo Modelo	Code Codice Kode Code Código Código	Standard / Optional	Page
UNOCODE	A4	D705691ZB	optional	39
	CW1011	D702855ZB	optional	39
	CW1012	D702851ZB	optional	39
	CW1014MC	D702853ZB	optional	39
	CW20FM	D702854ZB	optional	39
	D1	D705634ZB	optional	39
	DK2	D702849ZB	optional	39
	GB1	D705690ZB	optional	47
	P24	D713055ZB	optional	40
	P26	D713125ZB	optional	40
	P27	D713126ZB	optional	40
	P37	D727882ZB	optional	41
	S1	D700747ZB	optional	41
	S3	D706199ZB	optional	41
	SG13	D712450ZB	optional	46
	U01	D716549ZB	optional	41
	U02W	D706249ZB	optional	41
	U05W	D706731ZB	optional	41
	U07W	D709224ZB	optional	41
	U08W	D709225ZB	optional	41

Key Cutting Machines Duplicatrici Schlüsselkopiermaschinen Machines à tailler les clés Duplicadoras Duplicadora	Model Modello Modell Modél Modelo Modelo	Code Codice Kode Code Código Código	Standard / Optional	Page
UNOCODE 299	U01	D716549ZB	standard	41
	02	D702845ZB	optional	39
	03	D702846ZB	optional	39
	04	D702847ZB	optional	39
	05	D702837ZB	optional	46
	06	D705040ZB	optional	46
	07	D705689ZB	optional	39
	05W	D705633ZB	optional	47
	06W	D706128ZB	optional	47
	A2	D702221ZB	optional	39
	A3	D702222ZB	optional	39
	A4	D705691ZB	optional	39
	CW1011	D702855ZB	optional	39
	CW1012	D702851ZB	optional	39
	CW1014MC	D702853ZB	optional	39
	CW20FM	D702854ZB	optional	39
	D1	D705634ZB	optional	39
	DK2	D702849ZB	optional	39
	GB1	D705690ZB	optional	47
	P24	D713055ZB	optional	40

Electronic Key Cutting Machines

Duplicatrici Elettroniche / Elektronische Schlüsselkopiermaschinen / Machines à Tailler les clés Électronique / Máquinas Duplicadoras Electrónicas

Máquinas Duplicadoras Electrónicas

Key Cutting Machines Duplicatrici Schlüsselkopiermaschinen Machines à tailler les clés Duplicadoras Duplicadora	Model Modelo Modell Modél Modelo Modelo	Code Codice Kode Code Código Código	Standard / Optional	Page
UNOCODE 299	P26	D713125ZB	optional	40
	P27	D713126ZB	optional	40
	P37	D727882ZB	optional	41
	S1	D700747ZB	optional	41
	S3	D706199ZB	optional	41
	SG13	D712450ZB	optional	46
	SG13W	D723158ZB	optional	47
	SG27W	D736505ZB	optional	47
	U02W	D706249ZB	optional	41
	U05W	D706731ZB	optional	41
	U07W	D709224ZB	optional	41
U08W	D709225ZB	optional	41	
UNOCODE 399	U01W	D734910ZB	standard	41
	02	D702845ZB	optional	39
	03	D702846ZB	optional	39
	04	D702847ZB	optional	39
	05	D702837ZB	optional	46
	06	D705040ZB	optional	46
	07	D705689ZB	optional	39
	05W	D705633ZB	optional	47

Key Cutting Machines Duplicatrici Schlüsselkopiermaschinen Machines à tailler les clés Duplicadoras Duplicadora	Model Modelo Modell Modél Modelo Modelo	Code Codice Kode Code Código Código	Standard / Optional	Page
UNOCODE 399	06W	D706128ZB	optional	47
	A2	D702221ZB	optional	39
	A3	D702222ZB	optional	39
	A4	D705691ZB	optional	39
	CW1011	D702855ZB	optional	39
	CW1012	D702851ZB	optional	39
	CW1014MC	D702853ZB	optional	39
	CW20FM	D702854ZB	optional	39
	D1	D705634ZB	optional	39
	DK2	D702849ZB	optional	39
	GB1	D705690ZB	optional	47
	P24	D713055ZB	optional	40
	P26	D713125ZB	optional	40
	P27	D713126ZB	optional	40
	P37	D727882ZB	optional	41
	S1	D700747ZB	optional	41
	S3	D706199ZB	optional	41
	SG13	D712450ZB	optional	46
	SG13W	D723158ZB	optional	47
	SG27W	D736505ZB	optional	47

Electronic Key Cutting Machines

Duplicatrici Elettroniche / Elektronische Schlüsselkopiermaschinen / Machines à Tailler les clés Électronique / Máquinas Duplicadoras Electrónicas
Máquinas Duplicadoras Electrónicas

Key Cutting Machines Duplicatrici Schlüsselkopiermaschinen Machines à tailler les clés Duplicadoras Duplicadora	Model Modello Modell Modél Modelo Modelo	Code Codice Kode Code Código Código	Standard / Optional	Page
UNOCODE 399	U01	D716549ZB	optional	41
	U02W	D706249ZB	optional	41
	U05W	D706731ZB	optional	41
	U07W	D709224ZB	optional	41
	U08W	D709225ZB	optional	41
UNOCODE 399 EVO	U01W	D734910ZB	standard	41
	02	D702845ZB	optional	39
	03	D702846ZB	optional	39
	04	D702847ZB	optional	39
	05	D702837ZB	optional	46
	06	D705040ZB	optional	46
	07	D705689ZB	optional	39
	05W	D705633ZB	optional	47
	06W	D706128ZB	optional	47
	A2	D702221ZB	optional	39
	A3	D702222ZB	optional	39
	A4	D705691ZB	optional	39
	CW1011	D702855ZB	optional	39
	CW1012	D702851ZB	optional	39
	CW1014MC	D702853ZB	optional	39

Key Cutting Machines Duplicatrici Schlüsselkopiermaschinen Machines à tailler les clés Duplicadoras Duplicadora	Model Modello Modell Modél Modelo Modelo	Code Codice Kode Code Código Código	Standard / Optional	Page
UNOCODE 399 EVO	CW20FM	D702854ZB	optional	39
	D1	D705634ZB	optional	39
	DK2	D702849ZB	optional	39
	GB1	D705690ZB	optional	47
	P24	D713055ZB	optional	40
	P26	D713125ZB	optional	40
	P27	D713126ZB	optional	40
	P37	D727882ZB	optional	41
	S1	D700747ZB	optional	41
	S3	D706199ZB	optional	41
	SG13	D712450ZB	optional	46
	SG27W	D736505ZB	optional	47
	U01	D716549ZB	optional	41
	U02W	D706249ZB	optional	41
	U05W	D706731ZB	optional	41
	U07W	D709224ZB	optional	41
	U08W	D709225ZB	optional	41
	UNOCODE 399 PLUS	P41	D738583ZB	optional
SG27W		D736505ZB	optional	47
VIPER	W101	D709238ZB	standard	54

Electronic Key Cutting Machines

Duplicatrici Elettroniche / Elektronische Schlüsselkopiermaschinen / Machines à Tailler les clés Électronique / Máquinas Duplicadoras Electrónicas
Máquinas Duplicadoras Electrónicas

Key Cutting Machines Duplicatrici Schlüsselkopiermaschinen Machines à tailler les clés Duplicadoras Duplicadora	Model Modelo Modell Modél Modelo Modelo	Code Codice Kode Code Código Código	Standard / Optional	Page
VIPER	W114	D709481ZB	optional	54
	H114	D709482ZB	optional	54
	H158	D740825ZB	optional	55

Mechanical Key Cutting Machines

Duplicatrici meccaniche / Mechanische Schlüsselkopiermaschinen / Machines à Tailler les clés Mécaniques / Máquinas Duplicadoras Mecánicas / Máquinas Duplicadoras Mecánicas

Key Cutting Machines Duplicatrici Schlüsselkopiermaschinen Machines à tailler les clés Duplicadoras Duplicadora	Model Modello Modell Modél Modelo Modelo	Code Codice Kode Code Código Código	Standard / Optional	Page
BRAVO BD EVOLUTION	P36	D726407ZB	standard	41
	P01	D700875ZB	optional	39
	P01W	D704861ZB	optional	40
	P31	D717879ZB	optional	40
	P32	D717898ZB	optional	40
	P35	D722462ZB	optional	40
	P38	D731196ZB	optional	41
	BRAVO EVOLUTION	P01	D700875ZB	standard
A1S		D706157ZB	optional	39
A2S		D706158ZB	optional	39
A3S		D706159ZB	optional	39
P01W		D704861ZB	optional	40
P12		D709991ZB	optional	40
P13		D709993ZB	optional	40
P14		D709992ZB	optional	40
P15		D710207ZB	optional	40
P31		D717879ZB	optional	40
P32		D717898ZB	optional	40
P35		D722462ZB	optional	40
P36		D726407ZB	optional	41

Key Cutting Machines Duplicatrici Schlüsselkopiermaschinen Machines à tailler les clés Duplicadoras Duplicadora	Model Modello Modell Modél Modelo Modelo	Code Codice Kode Code Código Código	Standard / Optional	Page
BRAVO EVOLUTION	P38	D731196ZB	optional	41
BRAVO III	P32	D717898ZB	standard	40
	P01	D700875ZB	optional	39
	P01W	D704861ZB	optional	40
	P36	D726407ZB	optional	41
BRAVO JAPAN	P01W	D704861ZB	standard	40
	P01	D700875ZB	optional	39
	P31	D717879ZB	optional	40
	P32	D717898ZB	optional	40
	P35	D722462ZB	optional	40
	P36	D726407ZB	optional	41
BRAVO MAX JAPAN	P38	D731196ZB	optional	41
	P01W	D704861ZB	standard	40
	P01	D700875ZB	optional	39
	P31	D717879ZB	optional	40
	P32	D717898ZB	optional	40
	P35	D722462ZB	optional	40
BRAVO MAXIMA	P36	D726407ZB	optional	41
	P38	D731196ZB	optional	41
	P01	D700875ZB	standard	39

Mechanical Key Cutting Machines

Duplicatrici meccaniche / Mechanische Schlüsselkopiermaschinen / Machines à Tailler les clés Mécaniques / Máquinas Duplicadoras Mecánicas / Máquinas Duplicadoras Mecânicas

Key Cutting Machines Duplicatrici Schlüsselkopiermaschinen Machines à tailler les clés Duplicadoras Duplicadora	Model Modelo Modell Modél Modelo Modelo	Code Codice Code Code Código Código	Standard / Optional	Page
BRAVO MAXIMA	A1S	D706157ZB	optional	39
	A2S	D706158ZB	optional	39
	A3S	D706159ZB	optional	39
	P01W	D704861ZB	optional	40
	P31	D717879ZB	optional	40
	P32	D717898ZB	optional	40
	P35	D722462ZB	optional	40
	P36	D726407ZB	optional	41
	P38	D731196ZB	optional	41
	BRAVO PROFESSIONAL	P01	D700875ZB	standard
P01W		D704861ZB	optional	40
P31		D717879ZB	optional	40
P32		D717898ZB	optional	40
P35		D722462ZB	optional	40
P36		D726407ZB	optional	41
P38		D731196ZB	optional	41
BRAVO SOFER	P01	D700875ZB	standard	39
	A1S	D706157ZB	optional	39
	A2S	D706158ZB	optional	39
	A3S	D706159ZB	optional	39

Key Cutting Machines Duplicatrici Schlüsselkopiermaschinen Machines à tailler les clés Duplicadoras Duplicadora	Model Modelo Modell Modél Modelo Modelo	Code Codice Code Code Código Código	Standard / Optional	Page	
BRAVO SOFER	P01W	D704861ZB	optional	40	
	P12	D709991ZB	optional	40	
	P13	D709993ZB	optional	40	
	P14	D709992ZB	optional	40	
	P15	D710207ZB	optional	40	
	P31	D717879ZB	optional	40	
	P32	D717898ZB	optional	40	
	P35	D722462ZB	optional	40	
	P36	D726407ZB	optional	41	
	P38	D731196ZB	optional	41	
	BRAVO W-MAX	P01W	D704861ZB	standard	40
		P01	D700875ZB	optional	39
		P31	D717879ZB	optional	40
P32		D717898ZB	optional	40	
P35		D722462ZB	optional	40	
P36		D726407ZB	optional	41	
P38		D731196ZB	optional	41	
CROWN	-	D700077ZB	standard	73	
CROWN (T14)	-	D704541ZB	optional	73	
CROWN (T15)	-	D705407ZB	optional	73	

Mechanical Key Cutting Machines

Duplicatrici meccaniche / Mechanische Schlüsselkopiermaschinen / Machines à Tailler les clés Mécaniques / Máquinas Duplicadoras Mecánicas / Máquinas Duplicadoras Mecânicas

Key Cutting Machines Duplicatrici Schlüsselkopiermaschinen Machines à tailler les clés Duplicadoras Duplicadora	Model Modello Modell Modél Modelo Modelo	Code Codice Kode Code Código Código	Standard / Optional	Page
DELTA 2000	P21	D911868ZR	standard	40
	SG14	D712505ZB	optional	45
	SG15	D712506ZB	optional	45
	SG15W	D717968ZB	optional	45
	SG18	D913645ZR	optional	45
	SG19	D714448ZB	optional	45
DELTA 2000 AY	SG18	D913645ZR	standard	45
	P21	D911868ZR	optional	40
	SG13	D712450ZB	optional	46
	SG14	D712505ZB	optional	45
	SG15	D712506ZB	optional	45
	SG15W	D717968ZB	optional	45
DELTA 2000 BRAZIL	P21	D911868ZR	standard	40
	SG14	D712505ZB	optional	45
	SG15	D712506ZB	optional	45
	SG15W	D717968ZB	optional	45
	SG18	D913645ZR	optional	45
	SG19	D714448ZB	optional	45
DELTA 2000 FO	SG18	D913645ZR	standard	45

Key Cutting Machines Duplicatrici Schlüsselkopiermaschinen Machines à tailler les clés Duplicadoras Duplicadora	Model Modello Modell Modél Modelo Modelo	Code Codice Kode Code Código Código	Standard / Optional	Page
DELTA 2000 FO	P21	D911868ZR	optional	40
	SG13	D712450ZB	optional	46
	SG14	D712505ZB	optional	45
	SG15	D712506ZB	optional	45
	SG15W	D717968ZB	optional	45
	SG19	D714448ZB	optional	45
DELTA 2000 FS	SG14	D712505ZB	standard	45
	P21	D911868ZR	optional	40
	SG15	D712506ZB	optional	45
	SG15W	D717968ZB	optional	45
	SG18	D913645ZR	optional	45
	SG19	D714448ZB	optional	45
DELTA 2000 JAPAN	P21	D911868ZR	standard	40
	SG14	D712505ZB	optional	45
	SG15	D712506ZB	optional	45
	SG15W	D717968ZB	optional	45
	SG18	D913645ZR	optional	45
	SG19	D714448ZB	optional	45
DELTA 2000 MC	SG19	D714448ZB	optional	45
DELTA 2000 SOFER	P21	D911868ZR	standard	40

Mechanical Key Cutting Machines

Duplicatrici meccaniche / Mechanische Schlüsselkopiermaschinen / Machines à Tailler les clés Mécaniques / Máquinas Duplicadoras Mecánicas / Máquinas Duplicadoras Mecânicas

Key Cutting Machines Duplicatrici Schlüsselkopiermaschinen Machines à tailler les clés Duplicadoras Duplicadora	Model Modelo Modell Modél Modelo Modelo	Code Codice Code Code Código Código	Standard / Optional	Page
DELTA 2000 SOFER	SG14	D712505ZB	optional	45
	SG15	D712506ZB	optional	45
	SG15W	D717968ZB	optional	45
	SG18	D913645ZR	optional	45
	SG19	D714448ZB	optional	45
DELTA AB60P	SG13	D712450ZB	optional	46
DELTA PLUS	P21	D911868ZR	standard	40
	SG13	D712450ZB	optional	46
	SG14	D712505ZB	optional	45
	SG15	D712506ZB	optional	45
	SG15W	D717968ZB	optional	45
	SG18	D913645ZR	optional	45
	SG19	D714448ZB	optional	45
DUO	PR	D735282ZB	standard	41
	SG23 FLAT	D734963ZB	standard	46
DUO PLUS	PR	D735282ZB	standard	41
	SG23 FLAT	D734963ZB	standard	46
DUO POWER	PR	D735282ZB	standard	41
	SG23 FLAT	D734963ZB	standard	46
DUO SA	PR	D735282ZB	standard	41

Key Cutting Machines Duplicatrici Schlüsselkopiermaschinen Machines à tailler les clés Duplicadoras Duplicadora	Model Modelo Modell Modél Modelo Modelo	Code Codice Code Code Código Código	Standard / Optional	Page
DUO SA	SG23 FLAT	D734963ZB	standard	46
DUO SOFER	PR	D735282ZB	standard	41
	SG23 FLAT	D734963ZB	standard	46
LANCER PLUS	-	D711119ZB	standard	47
	SG6	D700204ZB	standard	45
	-	D703144ZB	optional	47
	-	D740601ZB	optional	47
	SG10	D700081ZB	optional	45
	SG5	D705374ZB	optional	45
OLYMPIC	-	D926289ZR	standard	47
OPERA III	SG1	D700080ZB	standard	45
	-	D700077ZB	standard	73
	-	D710596ZB	optional	73
	SG1W	D704784ZB	optional	45
	SG23 FLAT	D734963ZB	optional	46
	SG3	D700078ZB	optional	45
	SG3W	D711025ZB	optional	46
	SG4	D700079ZB	optional	46
	SG7	D703222ZB	optional	46
	SG8	D702863ZB	optional	46

Mechanical Key Cutting Machines

Duplicatrici meccaniche / Mechanische Schlüsselkopiermaschinen / Machines à Tailler les clés Mécaniques / Máquinas Duplicadoras Mecánicas / Máquinas Duplicadoras Mecánicas

Key Cutting Machines Duplicatrici Schlüsselkopiermaschinen Machines à tailler les clés Duplicadoras Duplicadora	Model Modelo Modell Modél Modelo Modelo	Code Codice Kode Code Código Código	Standard / Optional	Page
OPERA III (T14)	-	D704541ZB	optional	73
OPERA III (T15)	-	D705407ZB	optional	73
OPERA III SK	-	D710596ZB	optional	73
OPERA IV	SG1	D700080ZB	standard	45
	-	D700077ZB	optional	73
	SG1W	D704784ZB	optional	45
	SG23 FLAT	D734963ZB	optional	46
	SG3	D700078ZB	optional	45
	SG3W	D711025ZB	optional	46
	SG4	D700079ZB	optional	46
	SG7	D703222ZB	optional	46
SG8	D702863ZB	optional	46	
POKER PLUS	P01	D700875ZB	standard	39
POKER S	P01	D700875ZB	standard	39
REKORD	P01	D700875ZB	standard	39
REKORD BRAZIL	P01	D700875ZB	standard	39
REKORD SOFER	P01	D700875ZB	standard	39
TARGA 2000	SG1	D700080ZB	standard	45
	-	D701677ZB	optional	46
	SG1W	D704784ZB	optional	45

Key Cutting Machines Duplicatrici Schlüsselkopiermaschinen Machines à tailler les clés Duplicadoras Duplicadora	Model Modelo Modell Modél Modelo Modelo	Code Codice Kode Code Código Código	Standard / Optional	Page
TARGA 2000	SG2	D701744ZB	optional	46
	SG23 FLAT	D734963ZB	optional	46
	SG3W	D711025ZB	optional	46
	SG4	D700079ZB	optional	46
	SG7	D703222ZB	optional	46
	SG8	D702863ZB	optional	46
	TECH3	SG1	D700080ZB	standard
-		D701677ZB	optional	46
SG1W		D704784ZB	optional	45
SG2		D701744ZB	optional	46
SG23 FLAT		D734963ZB	optional	46
SG3		D700078ZB	optional	45
SG3W		D711025ZB	optional	46
SG4		D700079ZB	optional	46
SG7		D703222ZB	optional	46
SG8	D702863ZB	optional	46	
TECHNICA	SG1	D700080ZB	standard	45
	-	D701677ZB	optional	46
	SG1W	D704784ZB	optional	45
	SG2	D701744ZB	optional	46

Mechanical Key Cutting Machines

Duplicatrici meccaniche / Mechanische Schlüsselkopiermaschinen / Machines à Tailler les clés Mécaniques / Máquinas Duplicadoras Mecánicas / Máquinas Duplicadoras Mecânicas

Key Cutting Machines Duplicatrici Schlüsselkopiermaschinen Machines à tailler les clés Duplicadoras Duplicadora	Model Modelo Modell Modél Modelo Modelo	Code Codice Kode Code Código Código	Standard / Optional	Page
TECHNICA	SG23 FLAT	D734963ZB	optional	46
	SG3	D700078ZB	optional	45
	SG3W	D711025ZB	optional	46
	SG4	D700079ZB	optional	46
	SG7	D703222ZB	optional	46
	SG8	D702863ZB	optional	46
TECHNICA UK	SG4	D700079ZB	standard	46



2

Double Angle Cutters

- IT Frese Prismatiche
- DE Prismen Fräser
- FR Fraises Isocèles
- ES Fresas Isósceles
- PT Fresas Isósceles

Double Angle Cutters

Frese Prismatiche / Prismen Fräser / Fraises Isocèles / Fresas Isósceles / Fresas Isòsceles

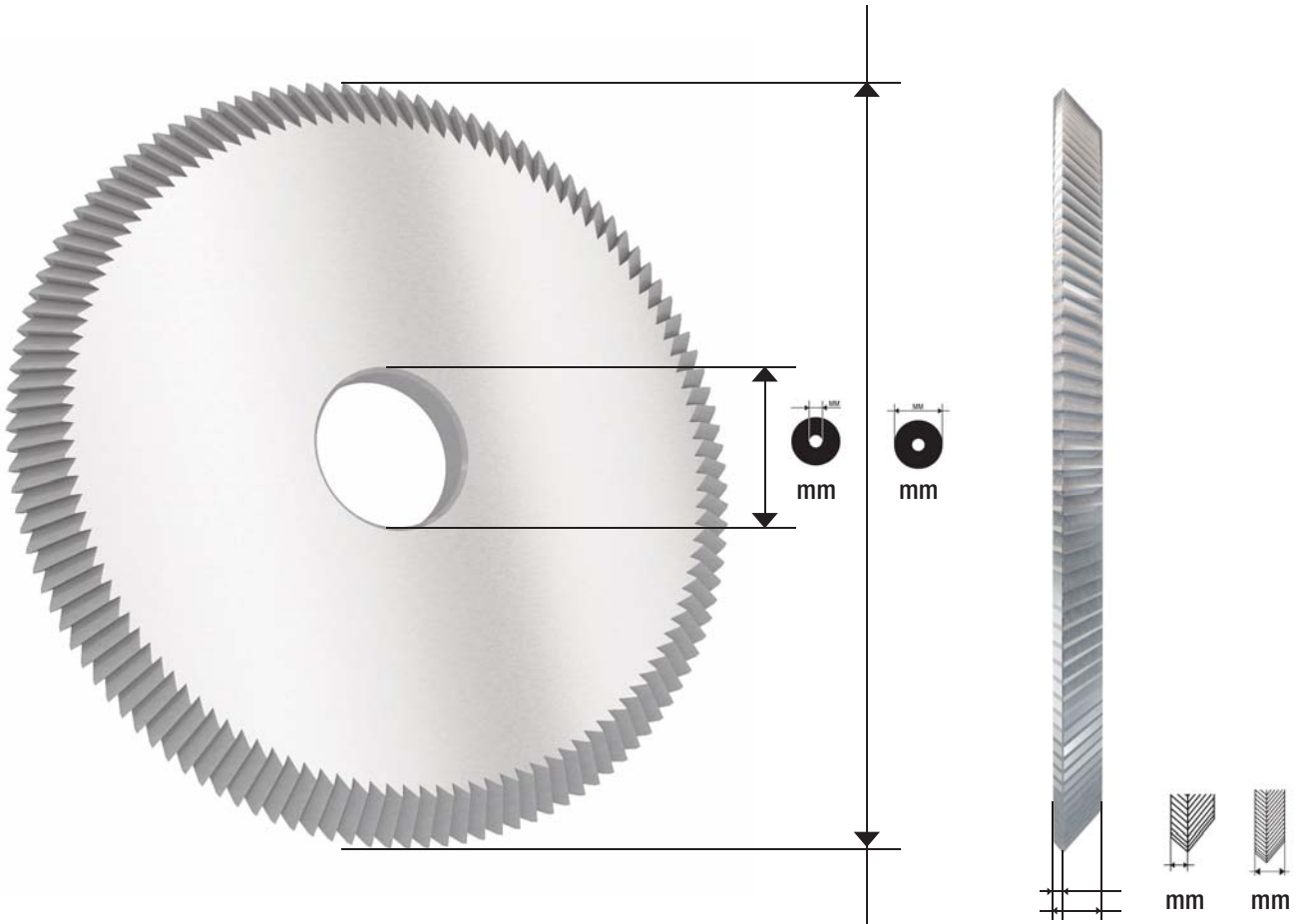

Symbols / Segni convenzionali / Unterscheidungszeichen / Signes conventionnels / Señales convencionales / Símbolos convencionais



Carbide cutter
Fresa in metallo duro
Hartmetall Fräser
Fraise au carbure
Fresa en acero duro
Fresa em aço duro

HSS

High Speed Steel
Acciaio Super Rapido
Hochleistung-Schnellstahl
Acier Super Rapide
Acero Super Rápido
Aço Super Rápido



mm

External diameter
Diametro esterno
Aussen-Durchmesser
Diamètre extérieur
Diámetro exterior
Diâmetro externo



mm

Internal diameter
Diametro interno
Innen-Durchmesser
Alésage
Diámetro interior
Diâmetro interno



mm

Cutter thickness
Spessore
Stärke
Épaisseur
Espesor
Espessura



Cutting angle
Angolo di taglio
Einschnittwinkel
Angle de coupe
Ángulo de corte
Ângulo de corte



mm

Cutter tip width
Piano di cifratura
Flach-Einschnitt
Partie plate angle de coupe
Parte llana ángulo de corte
Largura da ponta da fresa









mm

Distance from the center to the side
Distanza dal centro al lato
Abstand vom Mittelpunkt des Fräasers zur Seite
Distance entre le centre de la fraise et son bord
Distancia desde el centro hacia el lado
Distância do centro à lateral

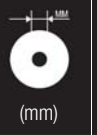









Double Angle Cutters

Frese Prismatische / Prismen Fräser / Fraises Isocèles / Fresas Isósceles / Fresas Isósceles

Model Modello Modell Modél Modelo Modelo	Code Codice Code Code Código Código	 HSS	 (mm)	 (mm)	 (mm)	 α°	 (mm)	No. of teeth Numero denti Zähne Nombre de dents Número de dientes Número de dentes	 (mm)	Key Cutting Machines Duplicatrici Schlüsselkopiermaschinen Machines à tailler les clés Duplicadoras Duplicadoras
02	D702845ZB	HSS	60,4	9,52	7,6	100	1	80	2,8	UNOCODE UNOCODE 299 UNOCODE 399 UNOCODE 399 EVO ULTRACODE
03	D702846ZB	HSS	60,4	9,52	6,9	100	1	80	2,1	UNOCODE UNOCODE 299 UNOCODE 399 UNOCODE 399 EVO ULTRACODE
04	D702847ZB	HSS	60,4	9,52	7,2	85	1	72	2,4	UNOCODE UNOCODE 299 UNOCODE 399 UNOCODE 399 EVO ULTRACODE
07	D705689ZB	HSS	60,4	9,52	7,2	90	0,6	80	2,4	UNOCODE UNOCODE 299 UNOCODE 399 UNOCODE 399 EVO ULTRACODE
A1S	D706157ZB	HSS	80	16	9,5	110	0	110	4,75	BRAVO EVOLUTION BRAVO MAXIMA / BRAVO SOFER
A2	D702221ZB	HSS	60,4	9,52	8,95	90	0,8	80	4,2	UNOCODE / UNOCODE 299 UNOCODE 399 UNOCODE 399 EVO ULTRACODE
A2S	D706158ZB	HSS	80	16	8,95	90	0,8	110	4,2	BRAVO EVOLUTION BRAVO MAXIMA / BRAVO SOFER
A3	D702222ZB	HSS	60,4	9,52	9,5	90	1,5	80	4,75	UNOCODE / UNOCODE 299 UNOCODE 399 UNOCODE 399 EVO ULTRACODE
A3S	D706159ZB	HSS	80	16	9,5	90	1,5	110	4,75	BRAVO EVOLUTION BRAVO MAXIMA / BRAVO SOFER
A4	D705691ZB	HSS	60,4	9,52	8,9	110	0,55	80	4,15	UNOCODE UNOCODE 299 UNOCODE 399 UNOCODE 399 EVO ULTRACODE
CW1011	D702855ZB	HSS	60,4	9,52	7,35	90	1,2	80	2,6	UNOCODE UNOCODE 299 UNOCODE 399 UNOCODE 399 EVO ULTRACODE
CW1012	D702851ZB	HSS	60,4	9,52	9,5	85	0,32	80	4,75	UNOCODE UNOCODE 299 UNOCODE 399 UNOCODE 399 EVO ULTRACODE
CW1014MC	D702853ZB	HSS	60,4	9,52	9,5	100	1,3	80	4,75	UNOCODE UNOCODE 299 UNOCODE 399 UNOCODE 399 EVO ULTRACODE
CW20FM	D702854ZB	HSS	60,4	9,52	9,5	76	1,6	80	4,75	UNOCODE UNOCODE 299 UNOCODE 399 UNOCODE 399 EVO ULTRACODE
D1	D705634ZB	HSS	60,4	9,52	7,6	100	0,8	80	2,8	UNOCODE UNOCODE 299 UNOCODE 399 UNOCODE 399 EVO ULTRACODE
DK2	D702849ZB	HSS	60,4	8,55	8,55	105	0,7	80	3,75	UNOCODE UNOCODE 299 UNOCODE 399 UNOCODE 399 EVO ULTRACODE
P01	D700875ZB	HSS	80	16	5	84	0,15	110	1	BRAVO EVOLUTION BRAVO PROFESSIONAL BRAVO MAXIMA / BRAVO W-MAX BRAVO SOFER BRAVO BD EVOLUTION BRAVO JAPAN BRAVO MAX JAPAN / BRAVO III POKER PLUS / POKER S / REKORD REKORD BRAZIL / REKORD SOFER















Double Angle Cutters

Frese Prismatische / Prismen Fräser / Fraises Isocèles / Fresas Isósceles / Fresas Isòsceles

Model Modello Modell Modél Modelo	Code Codice Code Código Código	 HSS	 (mm)	 (mm)	 (mm)	 84°	 (mm)	No. of teeth Numero denti Zähne Nombre de dents Número de dientes	 (mm)	Key Cutting Machines Duplicatrici Schlüsselkopiermaschinen Machines à tailler les clés Duplicadoras
P01W	D704861ZB		80	16	5	84	0,15	80	1	BRAVO EVOLUTION BRAVO PROFESSIONAL BRAVO MAXIMA / BRAVO W-MAX BRAVO SOFER BRAVO BD EVOLUTION BRAVO JAPAN BRAVO MAX.JAPAN / BRAVO III POKER PLUS / POKER S
P03	D701642ZB	HSS	80	16	7	100	0	100	3	REKORD 2000
P12	D709991ZB	HSS	80	15,98	8,5	100	1,5	110	4	BRAVO EVOLUTION BRAVO SOFER
P13	D709993ZB	HSS	80	16	8,5	90	0,6	110	4,5	
P14	D709992ZB	HSS	80	16	7,9	104	0,4	110	3,9	
P15	D710207ZB	HSS	80	16	8,5	90	0,8	110	4,5	
P21	D911868ZR	HSS	60,4	9,52	5,25	84	0,15	70	0,5	DELTA 2000 / DELTA 2000 FO DELTA 2000 AY DELTA 2000 BRAZIL DELTA 2000 JAPAN DELTA 2000 FS DELTA 2000 SOFER / DELTA PLUS
P24	D713055ZB		60,4	9,52	7	100	1,2	70	3,5	UNOCODE UNOCODE 299 UNOCODE 399 UNOCODE 399 EVO ULTRACODE
P26	D713125ZB		64,6	9,52	3,4	113	0,8	70	1,7	
P27	D713126ZB		64,6	9,52	3,8	120	0,8	70	1,9	
P31	D717879ZB	HSS	80	16	7,9	92	0,8	110	3,9	BRAVO EVOLUTION BRAVO BD EVOLUTION BRAVO PROFESSIONAL BRAVO MAXIMA / BRAVO W-MAX BRAVO SOFER / BRAVO JAPAN BRAVO MAX JAPAN
P32	D717898ZB	HSS	80	16	5	80	0	110	0,5	BRAVO EVOLUTION BRAVO PROFESSIONAL BRAVO MAXIMA / BRAVO W-MAX BRAVO SOFER BRAVO BD EVOLUTION BRAVO JAPAN BRAVO MAX JAPAN / BRAVO III
P35	D722462ZB	HSS	80	16	8	82	0,9	110	4	BRAVO EVOLUTION BRAVO BD EVOLUTION BRAVO PROFESSIONAL BRAVO MAXIMA / BRAVO W-MAX BRAVO SOFER / BRAVO JAPAN BRAVO MAX JAPAN

Double Angle Cutters

Frese Prismatiche / Prismen Fräser / Fraises Isocèles / Fresas Isósceles / Fresas Isòsceles

Model Modello Modell Modél Modelo	Code Codice Code Código Código	 HSS	 (mm)	 (mm)	 (mm)	 α°	 (mm)	No. of teeth Numero denti Zähne Nombre de dents Número de dientes Número de dentes	 (mm)	Key Cutting Machines Duplicatrici Schlüsselkopiermaschinen Machines à tailler les clés Duplicadoras Duplicadoras
P36	D726407ZB	HSS	80	16	5	84	0,15	110	1	BRAVO EVOLUTION BRAVO PROFESSIONAL BRAVO MAXIMA / BRAVO W-MAX BRAVO SOFER BRAVO BD EVOLUTION BRAVO JAPAN BRAVO MAX JAPAN / BRAVO III
P37	D727882ZB		60,4	9,52	4,8	40	0,1	70	0,05	UNOCODE UNOCODE 299 UNOCODE 399 UNOCODE 399 EVO ULTRACODE
P38	D731196ZB	HSS	80	16	8,5	90	1,3	110	0	BRAVO EVOLUTION BRAVO BD EVOLUTION BRAVO PROFESSIONAL BRAVO MAXIMA / BRAVO W-MAX BRAVO SOFER / BRAVO JAPAN / BRAVO MAX JAPAN
P41	D738583ZB		60,4	9,52	9,5	75	0,75	70	4,75	UNOCODE 399 PLUS
PR	D735282ZB	HSS	80	16	5	84	0,15	100	0	DUO / DUO PLUS / DUO SA DUO POWER / DUO SOFER
S1	D700747ZB	HSS	60,4	9,52	8,8	104	0,4	80	4	UNOCODE UNOCODE 299 UNOCODE 399 UNOCODE 399 EVO ULTRACODE
S3	D706199ZB	HSS	60,4	9,52	9,5	90	1,3	80	4,75	UNOCODE UNOCODE 299 UNOCODE 399 UNOCODE 399 EVO ULTRACODE
U01	D716549ZB	HSS	60,4	9,52	5,25	80	0,1	70	0,5	UNOCODE UNOCODE 299 UNOCODE 399 UNOCODE 399 EVO ULTRACODE LEONARDO
U01W	D734910ZB		60,4	9,52	5,25	80	0,1	70	0,5	UNOCODE / UNOCODE 399 / UNOCODE 399 EVO
U02W	D706249ZB		60,4	9,52	4,75	40	0,15	60	0	UNOCODE UNOCODE 299 UNOCODE 399 UNOCODE 399 EVO ULTRACODE
U05W	D706731ZB		60,4	9,52	5,25	90	0,4	60	0,5	UNOCODE UNOCODE 299 UNOCODE 399 UNOCODE 399 EVO ULTRACODE
U07W	D709224ZB		60,4	9,52	5,25	112	0,1	60	0,5	
U08W	D709225ZB		60,4	9,52	5,25	100	0,4	60	0,5	



3

Milling Slot Cutters

IT	Frese a Seghetto
DE	Schlitzfräser
FR	Fraises Scie
ES	Fresas Dentadas
PT	Fresas com Dentes

P. 47	Special Cutters
	Frese Speciali
	Spezialfräser
	Fraises Spéciales
	Fresas Especiales
	Fresas Especiais

Milling Slot Cutters

Frese a Seghetto / Schlitzfräser / Fraises Scie / Fresas Dentadas / Fresas com Dentes

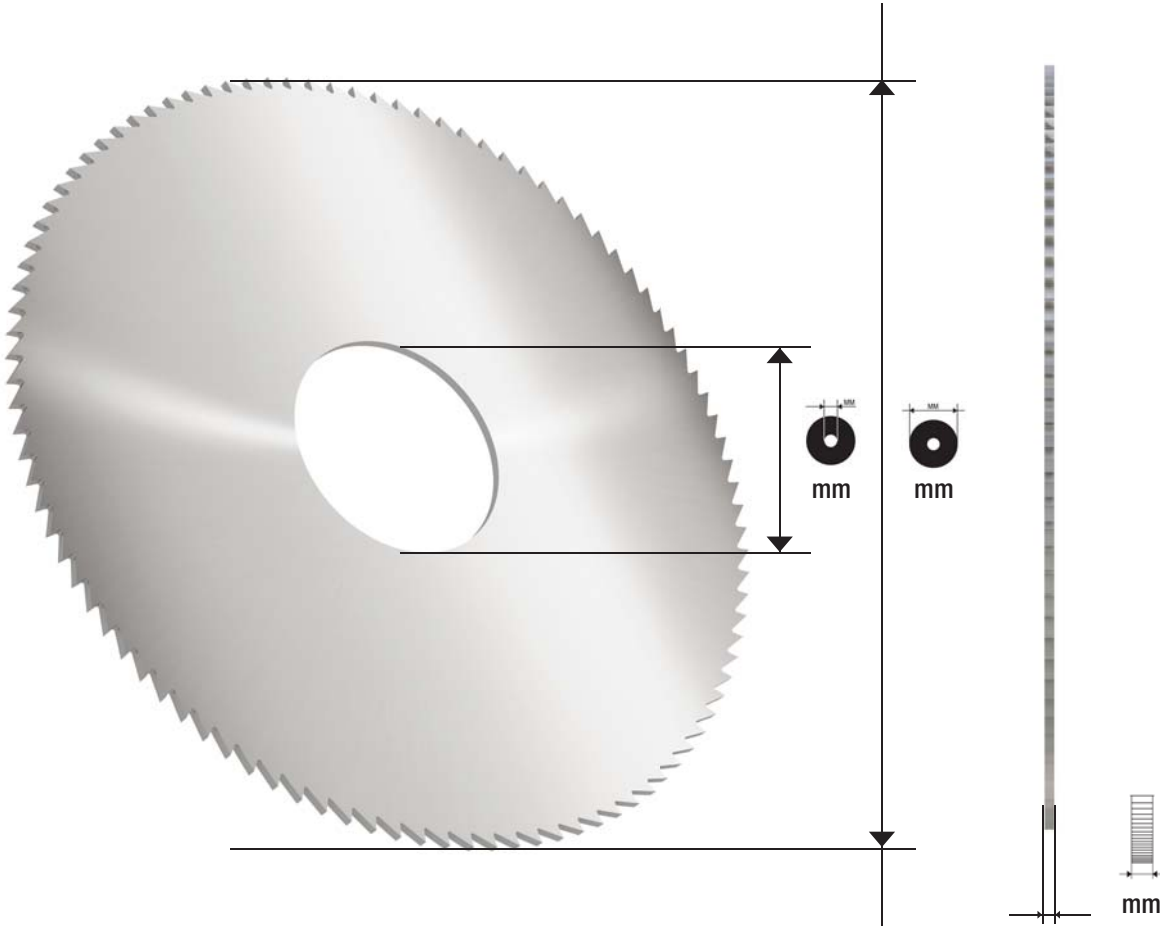

Symbols / Segni convenzionali / Unterscheidungszeichen / Signes conventionnels / Señales convencionales / Sinais convencionais



Carbide cutter
Fresa in metallo duro
Hartmetall Fräser
Fraise au carbure
Fresa en acero duro
Fresa em aço duro

HSS

High Speed Steel
Acciaio Super Rapido
Hochleistung-Schnellstahl
Acier Super Rapide
Acero Super Rápido
Aço Super Rápido



External diameter
Diámetro externo
Aussen-Durchmesser
Diamètre extérieur
Diámetro exterior
Diámetro externo



Internal diameter
Diámetro interno
Innen-Durchmesser
Alésage
Diámetro interior
Diámetro interno

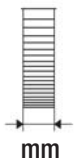

Cutter thickness
Spessore
Stärke
Épaisseur
Espesor
Espessura

















Milling cutter with side cuts
Fresa a tagli laterali
Fräser mit Seiteneinschnitten
Fraise à découpes latérales
Fresa con cortes laterales
Fresa a cortes laterais



Thread size
Filettatura
Gewindeschneiden
Dimension taraudage
Roscado
Tamanho da espiral















Milling Slot Cutters

Frese a Seghetto / Schlitzfräser / Fraises Scie / Fresas Dentadas / Fresas com Dentes

Model Modello Modell Modél Modelo	Code Codice Kode Code Código Código	 HSS	 (mm)	 (mm)	 (mm)			No. of teeth Numero denti Zähne Nombre de dents Número de dientes Número de dentes	Key Cutting Machines Duplicatrici Schlüsselkopiermaschinen Machines à tailler les clés Duplicadoras Duplicadoras
SG14	D712505ZB	HSS	60,4	9,52	1,14			70	DELTA 2000 DELTA 2000 FO DELTA 2000 AY DELTA 2000 BRAZIL
SG15	D712506ZB	HSS	60,4	9,52	0,76			70	DELTA 2000 JAPAN DELTA 2000 FS DELTA 2000 SOFER DELTA PLUS
SG15W	D717968ZB		60,4	9,52	0,76			70	
SG18	D913645ZR	HSS	64,6	9,52	2,4	X		40	
SG19	D714448ZB	HSS	64,6	9,52	1,5	X		70	DELTA 2000 DELTA 2000 FO DELTA 2000 AY DELTA 2000 BRAZIL DELTA 2000 JAPAN DELTA 2000 FS DELTA 2000 SOFER DELTA PLUS DELTA 2000 MC
PL1.00	D710036ZB		100	22	1			100	IDEA PRIMA LASER
PL1.25	D736154ZB		100	22	1,25			100	
PL1.50	D709696ZB		100	22	1,5			100	
PL1.70	D723584ZB		100	22	1,7			100	
PL1.90	D712527ZB		100	22	1,9			100	
PL2.20	D723422ZB		100	22	2,2			100	
PL2.40	D714465ZB		100	22	2,4			100	
SG5	D705374ZB	HSS	80	22	1,3			100	LANCER PLUS
SG6	D700204ZB	HSS	80	22	1,3	X		100	
SG10	D700081ZB	HSS	80	22	2			100	
SG1	D700080ZB	HSS	80	22	1,5			100	OPERA III OPERA IV TARGA 2000 TECH3 TECHNICA
SG1W	D704784ZB		80	22	1,5			100	
SG3	D700078ZB	HSS	80	22	1			100	











Milling Slot Cutters

Frese a Seghetto / Schlitzfräser / Fraises Scie / Fresas Dentadas / Fresas com Dentes

Model Modello Modell Modél Modelo Modelo	Code Codice Kode Code Código Código	 HSS	 (mm)	 (mm)	 (mm)			No. of teeth Numero denti Zähne Nombre de dents Número de dientes Número de dentes	Key Cutting Machines Duplicatrici Schlüsselkopiermaschinen Machines à tailler les clés Duplicadoras Duplicadoras
SG4	D700079ZB	HSS	80	22	1,25			100	OPERA III OPERA IV TARGA 2000 TECH3 TECHNICA TECHNICA UK
SG7	D703222ZB	HSS	80	22	1,4			100	OPERA III OPERA IV TARGA 2000 TECH3 TECHNICA
SG8	D702863ZB	HSS	80	22	1,75			100	TECH3 TECHNICA
SG23 FLAT	D734963ZB	HSS	80	22	1,25			100	DUO / DUO PLUS / DUO POWER DUO SA / DUO SOFER / OPERA IV TARGA 2000 / TECH3 / TECHNICA OPERA III
SG3W	D711025ZB		80	22	1			100	OPERA III / OPERA IV / TECH3 TECHNICA
PL1.6	D730435ZB		100	22	1,6			100	PRIMA LASER
PL1.65	D737787ZB		100	22	1,65			100	
PL1.8	D735331ZB		100	22	1,8			100	
PL1.25	D726023ZB		100	22	1,25			100	IDEA / PRIMA LASER
PL2.5	D738936ZB		100	22	2,5			100	PRIMA LASER
PL2.00	D723621ZB		100	22	2			100	
-	D701677ZB	TITANIUM	80	22	1,5			100	TARGA 2000 TECH3 TECHNICA
SG2	D701744ZB	HSS	80	22	1,5	X		100	
SG13	D712450ZB	HSS	64,6	9,52	2			70	UNOCODE / UNOCODE 299 UNOCODE 399 / UNOCODE 399 EVO / DELTA PLUS DELTA 2000 FO / DELTA 2000 AY DELTA AB60P
05	D702837ZB	HSS	60,4	9,52	1,8			66	UNOCODE UNOCODE 299 UNOCODE 399 UNOCODE 399 EVO ULTRACODE
06	D705040ZB	HSS	64,6	9,52	2,4			70	
05W	D705633ZB		60,4	9,52	1,8			68	

Milling Slot Cutters

Frese a Seghetto / Schlitzfräser / Fraises Scie / Fresas Dentadas / Fresas com Dentes

Model Modello Modell Modél Modelo	Code Codice Code Código Código	 HSS	 (mm)	 (mm)	 (mm)			No. of teeth Numero denti Zähne Nombre de dents Número de dientes Número de dentes	Key Cutting Machines Duplicatrici Schlüsselkopiermaschinen Machines à tailler les clés Duplicadoras Duplicadoras	
06W	D706128ZB		64,6	9,52	2,4			70	UNOCODE UNOCODE 299 UNOCODE 399 UNOCODE 399 EVO ULTRACODE	
GB1	D705690ZB	HSS	60,4	9,52	1,7			66		
SG13W	D723158ZB		64,6	9,52	2			70	UNOCODE 299 UNOCODE 399	
SG27W	D736505ZB		64,6	9,52	1,4			70	UNOCODE 299 / UNOCODE 399 UNOCODE 399 EVO UNOCODE 399 PLUS	
-	D726511ZB		63	16	1,25			80	OLYMPC	
-	D926289ZR		63	16	1,5			80		
Special Cutters Frese Speciali / Spezialfräser / Fraises Spéciales / Fresas Especiales / Fresas Especiais										
-	D703144ZB	HSS	25	0	1,25			8	40	LANCER PLUS
-	D711119ZB	HSS	25	5,2	1,25	X		40		
-	D740601ZB	HSS	25	0	1,25			8	40	



4

Cutters and Tracer Points for Electronic Key Cutting Machines

IT	Fresini e Tastatori per Duplicatrici Elettroniche
DE	Fräser und Taster für Elektronische Schlüsselkopiermaschine
FR	Fraises et Palpeurs pour Machines Électroniques
ES	Fresas y Palpadores para Duplicadoras Electrónicas
PT	Fresas e Palpadores para Duplicadoras Electrónicas

P. 51	Dimple Cutters Fresini per Chiavi Punzonate Fräser für Bohrmulden-Schlüsseln Fraises pour Clés à Points Fresas para Llaves de Seguridad Fresas para Chaves de Pontos
-------	--

P. 54	Laser Cutters Fresini per Chiavi Laser Fräser für Bahnen-Schlüsseln Fraisers pour Clés à taillage Laser Fresas para Llaves de Regata Fresar para Chaves com corte Laser
-------	---

P. 56	Special Cutters Frese Speciali Spezialfräser Fraises Spéciales Fresas Especiales Fresas Especiais
-------	---

Cutters and Tracer Points for Electronic Key Cutting Machines

Fresini e Tastatori per Duplicatrici Elettroniche / Fräser und Taster für Elektronische Schlüsselkopiermaschine / Fraises et Palpeurs pour Machines Électroniques / Fresas y Palpadores para Duplicadoras Electrónicas / Fresas e Palpadores para Duplicadoras Electrónicas

Dimple Cutters / Fresini per Chiavi Punzonate / Fräser für Bohrmulden-Schlüsseln / Fraises pour Clés à Points / Fresas para Llaves de Seguridad / Fresas para Chaves de Pontos



Laser Cutters / Fresini per Chiavi Laser / Fräser für Bahnen-Schlüsseln / Fraisers pour Clés à taillage Laser / Fresas para Llaves de Regata / Fresar para Chaves com corte Laser

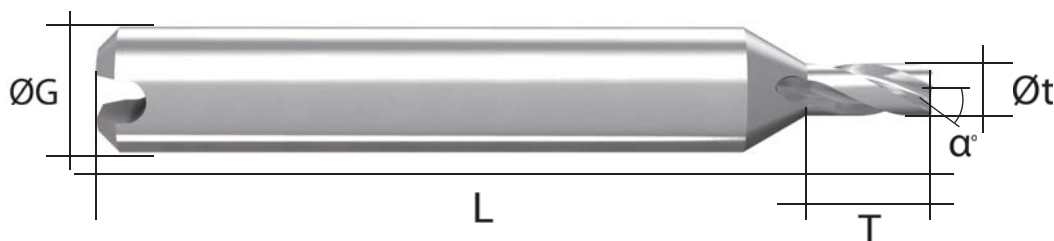

Special Cutters / Frese Speciali / Spezialfräser / Fraises Spéciales / Fresas Especiales / Fresas Especiais



Symbols / Segni convenzionali / Unterscheidungszeichen / Signes conventionnels / Señales convencionales / Sinais convencionais



Carbide cutter
Fresa in metallo duro
Hartmetall Fräser
Fraise au carbure
Fresa en acero duro
Fresa em aço duro

HSS

High Speed Steel
Acciaio Super Rapido
Hochleistung-Schnellstahl
Acier Super Rapide
Acero Super Rápido
Aço Super Rápido



Cutting angle
Angolo di taglio
Einschnittwinkel
Angle de coupe
Ángulo de corte
Ângulo de corte

L
mm

Full length
Lunghezza totale
Voller Länge
Pleine longueur
Largo total
Comprimento total

T

mm

Cutter length
Lunghezza tagliente
Schneidedurchlänge
Longeur de partie de taillage
Longitud zona de corte
Comprimento de corte

Øt

mm

Cutting diameter
Diámetro tagliente
Schneidedurchmesser
Diamètre de partie de taillage
Diámetro zona de corte
Diámetro de corte

















ØG

mm

Stem diameter
Diámetro gambo
Schaftdurchmesser
Diamètre de tige
Diámetro de tallo
Diámetro de talo























Cutters and Tracer Points for Electronic Key Cutting Machines

Fresini e Tastatori per Duplicatrici Elettroniche / Fräser und Taster für Elektronische Schlüsselkopiermaschine / Fraises et Palpeurs pour Machines Électroniques / Fresas y Palpadores para Duplicadoras Electrónicas / Fresas e Palpadores para Duplicadoras Electrónicas

Model Modello Modell Modél Modelo Modelo	Code Codice Code Code Código Código	 HSS	 α°	T (mm)	L (mm)	Øt (mm)	No. of Cuttings Numero taglianti Schneide Número de partes Número de cortes Número de dentes	ØG (mm)	Key Cutting Machines Duplicatrici Schlüsselkopiermaschinen Machines à tailler les clés Duplicadoras Duplicadoras
Dimple Cutters									
Fresini per Chiavi Punzonate / Fräser für Bohrmulden-Schlüsseln / Fraises pour Clés à Points / Fresas para Llaves de Seguridad / Fresas para Chaves de Pontos									
W102	D709239ZB		106	0	40	1	2	6	QUATTROCODE TRIAX-e.code TRIAX QUATTRO
W103	D709240ZB		90	0	40	0,8	2	6	
W104	D709241ZB		90	0	40	1,2	2	6	
W105	D709242ZB		90	0	40	0,7	2	6	
W106	D709243ZB		90	0	40	0,6	2	6	
W107	D709244ZB		90	0	40	0,9	2	6	
W108	D709245ZB		82	0	40	0,9	2	6	
W109	D709246ZB		110	0	40	0,4	2	6	
W113	D709250ZB		100	0	40	0,77	2	6	
W116	D709792ZB		90	0	40	1	2	6	
W118	D710018ZB		120	0	40	0,6	2	6	
W119	D710158ZB		85	0	40	0,3	2	6	
W122	D710424ZB		90	0	40	0,55	2	6	
W123	D710438ZB		76	0	40	0,9	2	6	
W130	D712391ZB		90	0	40	1,4	2	6	
W138	D722580ZB		80	0	40	0,7	2	6	
W140	D727335ZB		80	0	40	0,8	2	6	
W142	D728783ZB		100	0	40	1,2	2	6	
W146-ENGR.	D734267ZB		60	0	40	0,25	1	6	TRIAX QUATTRO TRIAX 2

















Cutters and Tracer Points for Electronic Key Cutting Machines

Fresini e Tastatori per Duplicatrici Elettroniche / Fräser und Taster für Elektronische Schlüsselkopiermaschine / Fraises et Palpeurs pour Machines Électroniques / Fresas y Palpadores para Duplicadoras Electrónicas / Fresas e Palpadores para Duplicadoras Electrónicas

Model Modello Modell Modél Modelo Modelo	Code Codice Code Code Código Código	 HSS		T (mm)	L (mm)	Øt (mm)	No. of Cuttings Numero taglienti Schneide Número de partes Número de cortes Número de dentes	ØG (mm)	Key Cutting Machines Duplicatrici Schlüsselkopiermaschinen Machines à tailler les clés Duplicadoras Duplicadoras
W147	D734848ZB		90	0	40	1,6	2	6	QUATTROCODE / TRIAX-e.code TRIAx QUATTRO
W151	D737951ZB		90	0	40	0,56	2	6	PROTECH
W152	D738003ZB		100	0	40	0,6	2	6	QUATTROCODE / TRIAX-e.code / TRIAx QUATTRO
W156	D740515ZB		90	0	40	0,56	1	6	PROTECH
W157	D740516ZB		90	0	40	0,56	1	6	
W203	D709643ZB		100	0	48	0,9	2	6	QUATTROCODE TRIAx-e.code TRIAx QUATTRO
W205	D710776ZB		90	0	48	0,2	2	6	
W206	D710777ZB		60	0	48	0,2	2	6	
W218	D712080ZB		90	0	40	0,6	2	6	
W222	D712789ZB		90	0	40	0,8	2	6	
W223	D714984ZB		90	0	48	2	2	6	
W224	D712653ZB		90	0	40	1	2	6	
W232	D714985ZB		100	0	48	1,5	2	6	
W233	D714986ZB		110	0	48	1	2	6	
W234	D713999ZB		95	0	40	0,8	2	6	
W236	D714139ZB		90	0	40	1,8	2	6	
W237	D714140ZB		90	0	40	0,85	2	6	
W240	D713286ZB		95	0	40	1	2	6	
W241	D713287ZB		100	0	40	0,5	2	6	
W262	D721670ZB		110	0	40	1,4	2	6	

















Cutters and Tracer Points for Electronic Key Cutting Machines

Fresini e Tastatori per Duplicatrici Elettroniche / Fräser und Taster für Elektronische Schlüsselkopiermaschine / Fraises et Palpeurs pour Machines Électroniques / Fresas y Palpadores para Duplicadoras Electrónicas / Fresas e Palpadores para Duplicadoras Electrónicas

Model Modello Modell Modél Modelo Modelo	Code Codice Code Code Código Código	 HSS	 α°	T (mm)	L (mm)	Øt (mm)	No. of Cuttings Numero taglienti Schneide Número de partes Número de cortes Número de dentes	ØG (mm)	Key Cutting Machines Duplicatrici Schlüsselkopiermaschinen Machines à tailler les clés Duplicadoras Duplicadoras
W269	D724570ZB		110	0	40	1,1	2	6	QUATTROCODE TRIAX-e.code TRIAX QUATTRO
W274	D726050ZB		105	0	40	1,2	2	6	
W283	D729319ZB		110	0	40	0,5	2	6	
W284	D729320ZB		120	0	40	0,2	2	6	
W286	D730617ZB		96	0	40	0,8	2	6	
W289	D731447ZB		100	0	40	0,8	2	6	
W290	D731956ZB		92	0	40	1	2	6	
W297	D735955ZB		100	0	40	1,1	2	6	
W299	D736503ZB		90	0	40	0,85	2	6	PROTECH
W301	D737183ZB		60	0	40	1,4	2	6	QUATTROCODE TRIAX-e.code TRIAX QUATTRO
W304	D737706ZB		90	0	40	2,25	2	6	
W307	D738677ZB		50	0	40	0,75	2	6	
W308	D738765ZB		90	0	40	1,1	2	6	PROTECH
W309	D739790ZB		104	0	40	0,45	2	6	QUATTROCODE / TRIAX-e.code / TRIAX QUATTRO
W500-UNIV.	D738590ZB		90	0	40	0,4	2	6	TRIAX QUATTRO
H102	D708743ZB	HSS	106	0	40	1	2	6	QUATTROCODE TRIAX-e.code TRIAX QUATTRO
H103	D709115ZB	HSS	90	0	40	0,8	2	6	
H104	D709116ZB	HSS	90	0	40	1,2	2	6	
H105	D708740ZB	HSS	90	0	40	0,7	2	6	
H106	D709117ZB	HSS	90	0	40	0,6	2	6	

















Cutters and Tracer Points for Electronic Key Cutting Machines

Fresini e Tastatori per Duplicatrici Elettroniche / Fräser und Taster für Elektronische Schlüsselkopiermaschine / Fraises et Palpeurs pour Machines Électroniques / Fresas y Palpadores para Duplicadoras Electrónicas / Fresas e Palpadores para Duplicadoras Electrónicas

Model Modello Modell Modél Modelo Modelo	Code Codice Code Code Código Código	 HSS	 α°	T (mm)	L (mm)	Øt (mm)	No. of Cuttings Numero taglienti Schneide Número de partes Número de cortes Número de dentes	ØG (mm)	Key Cutting Machines Duplicatrici Schlüsselkopiermaschinen Machines à tailler les clés Duplicadoras Duplicadoras	
H107	D708741ZB	HSS	90	0	40	0,9	2	6	QUATTROCODE TRIAX-e.code TRIAX QUATTRO	
H108	D709118ZB	HSS	82	0	40	0,9	2	6		
H109	D709119ZB	HSS	110	0	40	0,4	2	6		
H113	D709123ZB	HSS	100	0	40	0,76	2	6		
H118	D710017ZB	HSS	120	0	40	0,6	1	6		
H119	D710157ZB	HSS	85	0	40	0,3	2	6		
H120	D710161ZB		85	0	40	0,3	2	6		
H138	D722573ZB	HSS	80	0	40	0,7	2	6		
Laser Cutters										
Fresini per Chiavi Laser / Fräser für Bahnen-Schlüsseln / Fraisers pour Clés à taillage Laser / Fresas para Llaves de Regata / Fresar para Chaves com corte Laser										
W101	D709238ZB		0	6	40	2,5	3	6	QUATTROCODE / TRIAX-e.code TRIAX QUATTRO / VIPER	
W114	D709482ZB		0	3	40	2	2	6		
H114	D709481ZB		0	3	40	2	2	6		
W101T-LEXUS	D714471ZB		0	3	40	2,5	3	6	QUATTROCODE TRIAX-e.code TRIAX QUATTRO	
W114	D709482ZB		0	3	40	2	2	6		
W129	D711604ZB		0	3	40	3	3	6		
W131	D712633ZB		0	5	40	6	3	6		
W133	D715168ZB		0	1,5	40	2,6	3	6		
W134	D723062ZB		0	5	40	4	3	6		
W148	D735439ZB		0	1,5	40	1,52	2	6		
W202	D709362ZB		0	6	48	3,5	3	6		
W209	D711009ZB		0	6	40	2,5	3	6		
W215	D711605ZB		0	1,5	40	3,05	1	6		





















Cutters and Tracer Points for Electronic Key Cutting Machines

Fresini e Tastatori per Duplicatrici Elettroniche / Fräser und Taster für Elektronische Schlüsselkopiermaschine / Fraises et Palpeurs pour Machines Électroniques / Fresas y Palpadores para Duplicadoras Electrónicas / Fresas e Palpadores para Duplicadoras Electrónicas

Model Modello Modell Modél Modelo Modelo	Code Codice Code Code Código Código	 HSS	 α°	T (mm)	L (mm)	Øt (mm)	No. of Cuttings Numero taglienti Schneide Número de partes Número de cortes Número de dentes	ØG (mm)	Key Cutting Machines Duplicatrici Schlüsselkopiermaschinen Machines à tailler les clés Duplicadoras Duplicadoras
W216	D711606ZB		0	3	40	3	1	6	QUATTROCODE TRIAX-e.code TRIAX QUATTRO
W219	D712374ZB		0	1,5	40	1,22	2	6	
W220	D712480ZB		0	3	40	3,2	3	6	
W248	D714236ZB		0	12	48	5	3	6	
W249	D714440ZB		0	3	40	2,28	2	6	
W252	D715028ZB		0	1,5	40	1,5	2	6	
W260	D717658ZB		0	12	48	4	3	6	
W268	D717483ZB		0	2	40	1,6	2	6	
W281	D728858ZB		0	1,5	48	1,7	2	6	
W285	D729942ZB		0	3	40	2,3	2	6	
W288	D731309ZB		0	6	40	2,25	2	6	
W292	D734217ZB		0	7	40	5	2	6	
W303	D737705ZB		60	0	40	1,15	2	6	
W305	D738391ZB		0	2,5	40	1,3	2	6	PROTECH
W312	D741396ZB		0	3	40	1,07	2	6	
H101	D708742ZB	HSS	0	3	40	2,5	3	6	QUATTROCODE TRIAX-e.code TRIAX QUATTRO VIPER
H114	D709481ZB	HSS	0	3	40	2	2	6	
H131	D712438ZB	HSS	0	5	40	6	3	6	
H158	D740825ZB	HSS	0	5	40	6	3	6	

Cutters and Tracer Points for Electronic Key Cutting Machines























Fresini e Tastatori per Duplicatrici Elettroniche / Fräser und Taster für Elektronische Schlüsselkopiermaschine / Fraises et Palpeurs pour Machines Électroniques / Fresas y Palpadores para Duplicadoras Electrónicas / Fresas e Palpadores para Duplicadoras Electrónicas

Model Modello Modell Modél Modelo Modelo	Code Codice Code Código Código	 HSS	 α°	T (mm)	L (mm)	Øt (mm)	No. of Cuttings Numero taglianti Schneide Número de partes Número de cortes Número de dentes	ØG (mm)	Key Cutting Machines Duplicatrici Schlüsselkopiermaschinen Machines à tailler les clés Duplicadoras Duplicadoras
Special Cutters Frese Speciali / Spezialfräser / Fraises Spéciales / Fresas Especiales / Fresas Especiais									
W110	D709247ZB		(*)	0	40	0,6	1	6	QUATTROCODE TRIAX-e.code TRIAX QUATTRO
W111	D709248ZB		(*)	0	40	0	2	6	
W112	D709249ZB		0	0	40	1,5	2	6	
W115	D709512ZB		(*)	0	40	0,86	1	6	
W117	D710042ZB		(*)	4	48	5	4	6	
W120	D710162ZB		(*)	0	48	0,76	1	6	
W121	D710177ZB		(*)	0	48	0,4	3	6	
W124	D710569ZB		(*)	0	40	0,8	2	6	
W125	D710659ZB		(*)	0	48	0	2	6	
W126	D711129ZB		(*)	0	48	0	2	6	
W127	D711127ZB		(*)	0	48	0	2	6	
W128	D711124ZB		(*)	0	48	0,7	1	6	
W132	D712737ZB		(*)	0	40	0	1	6	
W135	D721004ZB		(*)	0	48	0,56	2	6	
W136	D722178ZB		(*)	0	40	0,76	1	6	
W137	D722502ZB		(*)	0	40	0,35	1	6	
W139	D724961ZB		(*)	0	40	0	2	6	
W143	D729491ZB		(*)	0	48	0,56	1	6	
W144	D729493ZB		(*)	0	48	0,56	1	6	

(*) Special angle cutter / Fresino con angoli speciali / Fräser mit speziellen Winkeln / Fraise à angles spéciaux / Fresa con ángulos especiales / Fresa com ângulos especiais

Cutters and Tracer Points for Electronic Key Cutting Machines























Fresini e Tastatori per Duplicatrici Elettroniche / Fräser und Taster für Elektronische Schlüsselkopiermaschine / Fraises et Palpeurs pour Machines Électroniques / Fresas y Palpadores para Duplicadoras Electrónicas / Fresas e Palpadores para Duplicadoras Electrónicas

Model Modello Modell Modél Modelo Modelo	Code Codice Code Code Código Código	 /  HSS	 α°	T (mm)	L (mm)	Øt (mm)	No. of Cuttings Numero taglianti Schneide Número de partes Número de cortes Número de dentes	ØG (mm)	Key Cutting Machines Duplicatrici Schlüsselkopiermaschinen Machines à tailler les clés Duplicadoras Duplicadoras
W145	D729494ZB		(*)	0	48	0,8	2	6	QUATTROCODE TRIAX-e.code TRIAX QUATTRO
W149	D735457ZB		(*)	0	48	0,56	1	6	
W150	D736541ZB		(*)	0	40	1,6	2	6	
W153	D738415ZB		(*)	0	40	0,8	2	6	
W154	D738523ZB		(*)	0	40	0,8	2	6	
W159	D741034ZB		(*)	0	40	0,8	2	6	PROTECH
W201	D709361ZB		0	0	48	1,5	2	6	QUATTROCODE TRIAX-e.code TRIAX QUATTRO
W204	D709642ZB		0	10	48	0	2	6	
W207	D710838ZB		(*)	0	48	1,6	2	6	
W208	D710963ZB		0	10	48	0	2	6	
W210	D711023ZB		0	0	40	0	3	6	
W211	D711136ZB		(*)	5	48	0	4	6	
W212	D711229ZB		0	6	40	1	2	6	
W213	D711542ZB		(*)	0	40	1	2	6	
W214	D711554ZB		0	12	48	2,1	2	6	
W217	D711629ZB		(*)	0	52	0,46	2	6	
W221	D712713ZB		(*)	0	40	0,5	2	6	
W225	D712802ZB		(*)	0	40	1	2	6	
W226	D712682ZB		(*)	0	48	0,9	2	6	
W227	D712683ZB		(*)	0	48	0,9	2	6	

(*) Special angle cutter / Fresino con angoli speciali / Fräser mit speziellen Winkeln / Fraise à angles spéciaux / Fresa con ángulos especiales / Fresa com ângulos especiais

Cutters and Tracer Points for Electronic Key Cutting Machines





















Fresini e Tastatori per Duplicatrici Elettroniche / Fräser und Taster für Elektronische Schlüsselkopiermaschine / Fraises et Palpeurs pour Machines Électroniques / Fresas y Palpadores para Duplicadoras Electrónicas / Fresas e Palpadores para Duplicadoras Electrónicas

Model Modello Modell Modél Modelo Modelo	Code Codice Code Code Código Código	 HSS	 α°	T (mm)	L (mm)	Øt (mm)	No. of Cuttings Numero taglianti Schneide Número de partes Número de cortes Número de dentes	ØG (mm)	Key Cutting Machines Duplicatrici Schlüsselkopiermaschinen Machines à tailler les clés Duplicadoras Duplicadoras
W228	D712684ZB		(*)	0	48	0,9	2	6	QUATTROCODE TRIAx-e.code TRIAx QUATTRO
W231	D712921ZB		(*)	0	48	1,1	2	6	
W238	D714285ZB		(*)	0	40	0,8	1	6	
W239	D713218ZB		0	0	48	1,5	2	6	
W242	D713572ZB		0	8	48	0	2	6	
W243	D713573ZB		0	6	48	2,7	2	6	
W244	D713574ZB		(*)	0	48	1,2	1	6	
W245	D713575ZB		(*)	0	48	0,6	2	6	
W247	D713830ZB		(*)	0	40	1,96	2	6	
W251	D714647ZB		(*)	0	48	0,5	2	6	
W253	D716871ZB		(*)	0	48	0,6	2	6	
W255	D717065ZB		(*)	0	40	0,7	2	6	
W258	D717531ZB		0	3,5	40	2,5	1	6	
W259	D717546ZB		0	10	48	2,55	2	6	
W261	D721116ZB		(*)	0	48	0,8	2	6	
W265	D722000ZB		0	0	40	0	2	6	
W267	D722738ZB		(*)	0	40	0,8	2	6	
W270	D724672ZB		0	0	40	0	3	6	
W271	D725076ZB		0	0	40	0	3	6	
W272	D725622ZB		0	0	40	0	3	6	

(*) Special angle cutter / Fresino con angoli speciali / Fräser mit speziellen Winkeln / Fraise à angles spéciaux / Fresa con ángulos especiales / Fresa com ângulos especiais

Cutters and Tracer Points for Electronic Key Cutting Machines



Fresini e Tastatori per Duplicatrici Elettroniche / Fräser und Taster für Elektronische Schlüsselkopiermaschine / Fraises et Palpeurs pour Machines Électroniques / Fresas y Palpadores para Duplicadoras Electrónicas / Fresas e Palpadores para Duplicadoras Electrónicas

Model Modello Modell Modél Modelo Modelo	Code Codice Kode Code Código Código	 HSS	 α°	T (mm)	L (mm)	Øt (mm)	No. of Cuttings Numero taglianti Schnaide Número de partes Número de cortes Número de dentes	ØG (mm)	Key Cutting Machines Duplicatrici Schlüsselkopiermaschinen Machines à tailler les clés Duplicadoras Duplicadoras
W273	D726008ZB		0	0	40	0	3	6	QUATTROCODE TRIAX-e.code TRIAX QUATTRO
W275	D726404ZB		(*)	0	40	1	2	6	
W277	D728170ZB		(*)	0	48	1,05	2	6	
W278	D728514ZB		(*)	0	40	0,7	2	6	
W279	D728856ZB		(*)	0	48	0,7	2	6	
W280	D728857ZB		(*)	0	48	0,76	2	6	
W282	D729141ZB		0	0	40	0	3	6	
W287	D731048ZB		(*)	0	40	1,1	1	6	
W291	D732180ZB		(*)	0	40	0,55	2	6	
W293	D734544ZB		(*)	0	40	0,85	2	6	
W294	D734601ZB		(*)	0	40	0	2	6	
W295	D734579ZB	TITANIUM	(*)	0	40	0,8	1	6	
W296	D735973ZB		(*)	0	40	0,76	1	6	
W298	D737492ZB		0	0	40	0	2	6	
W300	D736794ZB		(*)	0	40	1,2	1	6	
W302	D737688ZB		0	0	40	0	2	6	
W306	D738450ZB		0	0	40	0	2	6	
W310	D737688ZB		0	0	40	0	3	6	
W311	D741395ZB		0	5,5	40	1,1	2	6	PROTECH
W313	D741452ZB		0	0	40	0	0	6	

(*) Special angle cutter / Fresino con angoli speciali / Fräser mit speziellen Winkeln / Fraise à angles spéciaux / Fresa con ángulos especiales / Fresa com ângulos especiais

Cutters and Tracer Points for Electronic Key Cutting Machines



Fresini e Tastatori per Duplicatrici Elettroniche / Fräser und Taster für Elektronische Schlüsselkopiermaschine / Fraises et Palpeurs pour Machines Électroniques / Fresas y Palpadores para Duplicadoras Electrónicas / Fresas e Palpadores para Duplicadoras Electrónicas

Model Modello Modell Modél Modelo Modelo	Code Codice Kode Code Código Código	 HSS	 α°	T (mm)	L (mm)	Øt (mm)	No. of Cuttings Numero taglianti Schneide Número de partes Número de cortes Número de dentes	ØG (mm)	Key Cutting Machines Duplicatrici Schlüsselkopiermaschinen Machines à tailler les clés Duplicadoras Duplicadoras
W314	D738450ZB		(*)	0	40	0,85	2	6	QUATTROCODE TRIAx-e.code TRIAx QUATTRO
H110	D709120ZB	HSS	(*)	0	40	0,6	1	6	
H110 (MAT. X85)	D710306ZB	HSS	(*)	0	40	0,6	1	6	
H111	D709121ZB	HSS	(*)	0	40	0	2	6	
H111 (MAT. X85)	D710307ZB	HSS	(*)	0	40	0	2	6	
H112	D709122ZB	HSS	0	0	40	1,5	2	6	
H112 (MAT. X85)	D710308ZB	HSS	0	0	40	1,5	2	6	
H115	D709511ZB	HSS	(*)	0	40	0,86	1	6	
H117	D709974ZB	HSS	(*)	4	48	5	4	6	
H126	D711128ZB	HSS	(*)	0	48	0	2	6	
H127	D711126ZB	HSS	(*)	0	48	0	2	6	
H128	D711125ZB	HSS	(*)	0	48	0,7	1	6	
H254	D717602ZB	HSS	(*)	0	40	0,6	1	6	

(*) Special angle cutter / Fresino con angoli speciali / Fräser mit speziellen Winkeln / Fraise à angles spéciaux / Fresa con ángulos especiales / Fresa com ângulos especiais

Cutters and Tracer Points for Electronic Key Cutting Machines

Fresini e Tastatori per Duplicatrici Elettroniche / Fräser und Taster für Elektronische Schlüsselkopiermaschine / Fraises et Palpeurs pour Machines Électroniques / Fresas y Palpadores para Duplicadoras Electrónicas / Fresas e Palpadores para Duplicadoras Electrónicas

Model Modello Modell Modél Modelo Modelo	Code Codice Code Code Código Código	 HSS	 α°	T (mm)	L (mm)	Øt (mm)	No. of Cuttings Numero taglienti Schneide Número de partes Número de cortes Número de dentes	ØG (mm)	Key Cutting Machines Duplicatrici Schlüsselkopiermaschinen Machines à tailler les clés Duplicadoras Duplicadoras
Tracer points Tastatori / Taster / Palpeurs / Palpadores / Palpadores									
U101	D909076ZR	-	-	-	48	1,2	-	6	QUATTROCODE
U101L/110-A	D735284ZB	-	-	-	43	1,2	-	6	QUATTROCODE TRIAX-e.code TRIAX QUATTRO
U102	D908994ZR	30	-	-	48	0,2	-	6	
U102TT	D917260ZR	30	-	-	26	0,2	-	4	
U103	D711108ZB	-	-	-	48	1	-	6	
U103TT	D917259ZR	-	-	-	21	1	-	4	



5

Cutters and Tracer Points for Mechanic Key Cutting Machines

IT	Fresini e Tastatori per Duplicatrici Meccaniche
DE	Fräser und Taster für Mechanische Schlüsselkopiermaschine
FR	Fraises et Palpeurs pour Machines Mécaniques
ES	Fresas y Palpadores para Duplicadoras Mecánicas
PT	Fresas e Palpadores para Duplicadoras Mecânicas

P. 65 Dimple Cutters
 Fresini per Chiavi Punzonate
 Fräser für Bohrmulden-Schlüsseln
 Fraises pour Clés à Points
 Fresas para Llaves de Seguridad
 Fresas para Chaves de Pontos

P. 69 Laser Cutters
 Fresini per Chiavi Laser
 Fräser für Bahnen-Schlüsseln
 Fraisers pour Clés à taillage Laser
 Fresas para Llaves de Regata
 Fresar para Chaves com corte Laser

P. 70 Special Cutters
 Frese Speciali
 Spezialfräser
 Fraises Spéciales
 Fresas Especiales
 Fresas Especiais

Cutters and Tracer points for Mechanic Key Cutting Machines

Fresini e Tastatori per Duplicatrici Meccaniche / Fräser und Taster für Mechanische Schlüsselkopiermaschine / Fraises et Palpeurs pour Machines Mécaniques
Fresas y Palpadores para Duplicadoras Mecánicas / Fresas e Palpadores para Duplicadoras Mecânicas

Dimple Cutters / Fresini per Chiavi Punzonate / Fräser für Bohrmulden-Schlüsseln / Fraises pour Clés à Points / Fresas para Llaves de Seguridad / Fresas para Chaves de Pontos

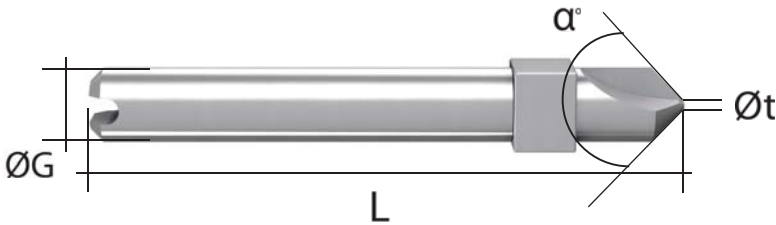

Laser Cutters / Fresini per Chiavi Laser / Fräser für Bahnen-Schlüsseln / Fraisers pour Clés à taillage Laser / Fresas para Llaves de Regata / Fresar para Chaves com corte Laser

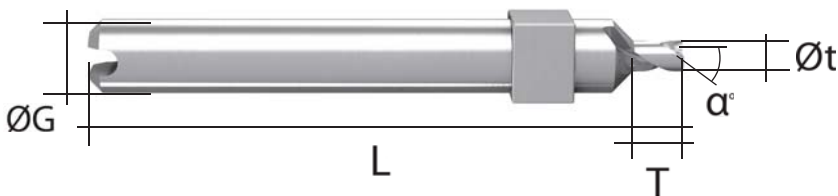

Special Cutters / Frese Speciali / Spezialfräser / Fraises Spéciales / Fresas Especiales / Fresas Especiais

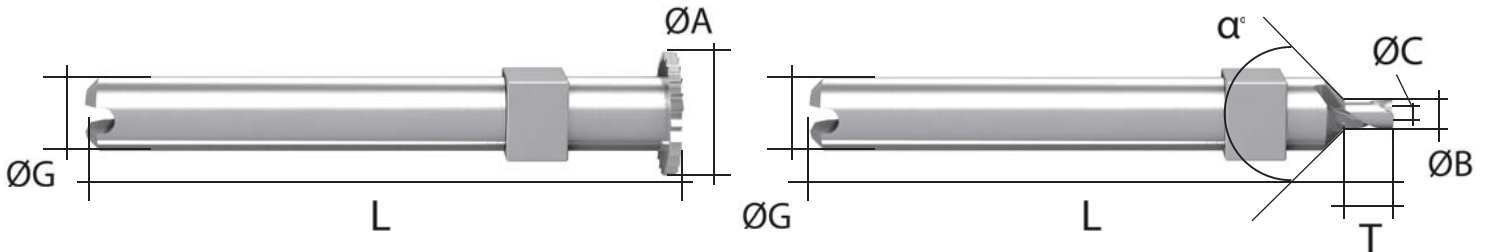

Symbols / Segni convenzionali / Unterscheidungszeichen / Signes conventionnels / Señales convencionales / Sinais convencionais



Carbide cutter
Fresa in metallo duro
Hartmetall Fräser
Fraise au carbure
Fresa en acero duro
Fresa em aço duro

HSS

High Speed Steel
Acciaio Super Rapido
Hochleistung-Schnellstahl
Acier Super Rapide
Acero Super Rápido
Aço Super Rápido

ØA

External diameter
Diametro esterno
Aussen-Durchmesser
Diamètre extérieur
Diámetro exterior
Diâmetro externo

mm



Cutting angle
Angolo di taglio
Einschnittwinkel
Angle de coupe
Ángulo de corte
Ângulo de corte

L

Full length
Lunghezza totale
Voller Länge
Pleine longueur
Largo total
Comprimento total

mm

T

Cutter length
Lunghezza tagliente
Schneidedurchlänge
Longeur de partie de taillage
Longitud zona de corte
Comprimento de corte

mm

Øt

Cutting diameter
Diametro tagliente
Schneidedurchmesser
Diamètre de partie de taillage
Diámetro zona de corte
Diâmetro de corte

mm

ØG

Stem diameter
Diametro gambo
Schaftdurchmesser
Diamètre de tige
Diámetro de tallo
Diâmetro de talo

mm

ØB

Cutting diameter
Diametro tagliente
Schneidedurchmesser
Diamètre de partie de taillage
Diámetro zona de corte
Diâmetro de corte

mm

ØC

Cutting diameter
Diametro tagliente
Schneidedurchmesser
Diamètre de partie de taillage
Diámetro zona de corte
Diâmetro de corte

mm

Cutters and Tracer points for Mechanic Key Cutting Machines

Fresini e Tastatori per Duplicatrici Meccaniche / Fräser und Taster für Mechanische Schlüsselkopiermaschine / Fraises et Palpeurs pour Machines Mécaniques
Fresas y Palpadres para Duplicadoras Mecánicas / Fresas e Palpadres para Duplicadoras Mecânicas

Tracer point		Cutters / Fresini / Fräser / Fraises / Fresas / Fresas											Key Cutting Machines Duplicatrici Schlüsselkopiermaschinen Machines à tailler les clés Duplicadoras Duplicadoras
Model Modello Modell Modelo Modelo	Code Codice Kode Code Código Código	Model Modello Modell Modelo Modelo	Code Codice Kode Code Código Código		$\varnothing A$ (mm)	α	T (mm)	L (mm)	$\varnothing t$ (mm)	No. of Cuttings	$\varnothing G$ (mm)	$\varnothing B$ $\varnothing C$ (mm)	

Dimple Cutters

Fresini per Chiavi Punzonate / Fräser für Bohrmulden-Schlüsseln / Fraises pour Clés à Points / Fresas para Llaves de Seguridad / Fresas para Chaves de Pontos

T1		F1	T1	D739972ZB	F1	D739971ZB	HSS	0	90	0	48	0,7	1	6	0 / 0	MATRIX PRO MATRIX EVO MATRIX SLX MATRIX SX MATRIX S
T1		F1W	T1	D739972ZB	F1W	D740418ZB		0	90	0	48	0,7	2	6	0 / 0	
T4		F4	T4	D740368ZB	F4	D740444ZB	HSS	0	90	0	48	0,4	1	6	0 / 0	
T4		F4W	T4	D740368ZB	F4W	D740454ZB		0	90	0	48	0,4	2	6	0 / 0	
T5		F5	T5	D740378ZB	F5	D740455ZB	HSS	0	90	0	48	0,9	1	6	0 / 0	
T5		F5W	T5	D740378ZB	F5W	D740466ZB		0	90	0	48	0,9	2	6	0 / 0	
T6		F6	T6	D740389ZB	F6	D740467ZB	HSS	0	106	0	48	1	1	6	0 / 0	
T6		F6W	T6	D740389ZB	F6W	D740476ZB		0	106	0	48	1	2	6	0 / 0	
T7		F7	T7	D740399ZB	F7	D740477ZB	HSS	0	72	0	48	0,8	1	6	0 / 0	

Cutters and Tracer points for Mechanic Key Cutting Machines

Fresini e Tastatori per Duplicatrici Meccaniche / Fräser und Taster für Mechanische Schlüsselkopiermaschine / Fraises et Palpeurs pour Machines Mécaniques
Fresas y Palpadores para Duplicadoras Mecánicas / Fresas e Palpadores para Duplicadoras Mecânicas

Tracer point		Cutters / Fresini / Fräser / Fraises / Fresas / Fresas											Key Cutting Machines Duplicatrici Schlüsselkopiermaschinen Machines à tailler les clés Duplicadoras Duplicadoras
Model Modello Modell Modél Modelo	Code Codice Kode Code Código	Model Modello Modell Modél Modelo	Code Codice Kode Code Código	 HSS	$\varnothing A$ (mm)	α 	T (mm)	L (mm)	$\varnothing t$ (mm)	No. of Cuttings	$\varnothing G$ (mm)	$\varnothing B$ $\varnothing C$ (mm)	

Dimple Cutters

Fresini per Chiavi Punzonate / Fräser für Bohrmulden-Schlüsseln / Fraises pour Clés à Points / Fresas para Llaves de Seguridad / Fresas para Chaves de Pontos

T7		F7W		T7	D740399ZB	F7W	D740478ZB		0	72	0	48	0,8	2	6	0 / 0	MATRIX PRO MATRIX EVO MATRIX SLX MATRIX SX MATRIX S
T13		F13		T13	D740341ZB	F13	D740410ZB	HSS	0	90	0	48	0,77	1	6	0 / 0	
T14		F1		T14	D740343ZB	F14	D740411ZB	HSS	0	90	0	48	0,9	1	6	0 / 0	
T20		F20		T20	D740349ZB	F20	D740419ZB	HSS	0	90	0	48	0,45	2	6	0 / 0	
T20		F20W		T20	D740349ZB	F20W	D740420ZB		0	90	0	48	0,45	2	6	0 / 0	
T24		F24		T24	D740353ZB	F24	D740425ZB	HSS	0	100	0	48	1,3	1	6	0 / 0	
T26		F26		T26	D740355ZB	F26	D740428ZB	HSS	0	82	0	48	0,8	1	6	0 / 0	
T28		F28		T28	D740357ZB	F28	D740430ZB	HSS	0	76	0	48	0,76	1	6	0 / 0	
T32		F32		T32	D740362ZB	F32	D740437ZB	HSS	0	100	0	48	0,8	1	6	0 / 0	

















Cutters and Tracer points for Mechanic Key Cutting Machines

Fresini e Tastatori per Duplicatrici Meccaniche / Fräser und Taster für Mechanische Schlüsselkopiermaschine / Fraises et Palpeurs pour Machines Mécaniques
Fresas y Palpadores para Duplicadoras Mecánicas / Fresas e Palpadores para Duplicadoras Mecânicas

Tracer point		Cutters / Fresini / Fräser / Fraises / Fresas / Fresas											Key Cutting Machines Duplicatrici Schlüsselkopiermaschinen Machines à tailler les clés Duplicadoras Duplicadoras
Model Modello Modell Model Modelo	Code Codice Kode Code Código	Model Modello Modell Model Modelo	Code Codice Kode Code Código	 HSS	$\varnothing A$ (mm)	α 	T (mm)	L (mm)	$\varnothing t$ (mm)	No. of Cuttings	$\varnothing G$ (mm)	$\varnothing B$ $\varnothing C$ (mm)	







Dimple Cutters

Fresini per Chiavi Punzonate / Fräser für Bohrmulden-Schlüsseln / Fraises pour Clés à Points / Fresas para Llaves de Seguridad / Fresas para Chaves de Pontos

T39		F39		T39	D740367ZB	F39	D740442ZB	HSS	0	90	0	48	0,6	1	6	0 / 0	MATRIX PRO MATRIX EVO MATRIX SLX MATRIX SX MATRIX S
T42		F42		T42	D740370ZB	F42	D740446ZB	HSS	0	100	0	48	0,7	1	6	0 / 0	
T45		F45		T45	D740373ZB	F45	D740449ZB	HSS	0	130	0	48	0,56	1	6	0 / 0	
T46		F46		T46	D740374ZB	F46	D740450ZB	HSS	0	100	0	48	0,65	1	6	0 / 0	
T47		F47		T47	D740375ZB	F47	D740451ZB	HSS	0	90	0	48	0,55	1	6	0 / 0	
T48		F48		T48	D740376ZB	F48	D740452ZB	HSS	0	90	0	48	0,65	1	6	0 / 0	
T49		F49		T49	D740377ZB	F49	D740453ZB	HSS	0	95	0	48	0,8	1	6	0 / 0	
T50		F50		T50	D740379ZB	F50	D740456ZB	HSS	0	100	0	48	0,5	1	6	0 / 0	
T55		F55		T55	D740384ZB	F55	D740461ZB	HSS	0	90	0	48	1	1	6	0 / 0	

Cutters and Tracer points for Mechanic Key Cutting Machines

Fresini e Tastatori per Duplicatrici Meccaniche / Fräser und Taster für Mechanische Schlüsselkopiermaschine / Fraises et Palpeurs pour Machines Mécaniques
Fresas y Palpadores para Duplicadoras Mecánicas / Fresas e Palpadores para Duplicadoras Mecânicas

Tracer point		Cutters / Fresini / Fräser / Fraises / Fresas / Fresas												Key Cutting Machines Duplicatrici Schlüsselkopiermaschinen Machines à tailler les clés Duplicadoras Duplicadoras	
Model Modello Modell Modelo Modelo	Code Codice Kode Code Código	Model Modello Modell Modelo Modelo	Code Codice Kode Code Código	 HSS	$\varnothing A$ (mm)	α 	T (mm)	L (mm)	$\varnothing t$ (mm)	No. of Cuttings	$\varnothing G$ (mm)	$\varnothing B$ $\varnothing C$ (mm)			
Dimple Cutters															
Fresini per Chiavi Punzonate / Fräser für Bohrmulden-Schlüsseln / Fraises pour Clés à Points / Fresas para Llaves de Seguridad / Fresas para Chaves de Pontos															
T59 	F59	T59	D740388ZB	F59	D740465ZB	HSS	0	90	0	48	0,8	1	6	0 / 0	MATRIX PRO MATRIX EVO MATRIX SLX MATRIX SX MATRIX S
T67 	F67	T67	D740396ZB	F67	D740473ZB	HSS	0	100	0	48	1,1	2	6	0 / 0	
T69 	F69	T69	D740398ZB	F69	D740475ZB	HSS	0	90	0	48	0,56	2	6	0 / 0	
T70 	F70	T70	D740342ZB	F70	D740483ZB	HSS	0	80	0	48	0,7	2	6	0 / 0	

Cutters and Tracer points for Mechanic Key Cutting Machines

Fresini e Tastatori per Duplicatrici Meccaniche / Fräser und Taster für Mechanische Schlüsselkopiermaschine / Fraises et Palpeurs pour Machines Mécaniques
Fresas y Palpadores para Duplicadoras Mecánicas / Fresas e Palpadores para Duplicadoras Mecânicas

Tracer point		Cutters / Fresini / Fräser / Fraises / Fresas / Fresas											Key Cutting Machines Duplicatrici Schlüsselkopiermaschinen Machines à tailler les clés Duplicadoras Duplicadoras
Model Modello Modell Modél Modelo	Code Codice Kode Code Código	Model Modello Modell Modél Modelo	Code Codice Kode Code Código		ØA (mm)	α° 	T (mm)	L (mm)	Øt (mm)	No. of Cuttings	ØG (mm)	ØB ØC (mm)	

Laser Cutters

Fresini per Chiavi Laser / Fräser für Bahnen-Schlüsseln / Fraisers pour Clés à taillage Laser / Fresas para Llaves de Regata / Fresar para Chaves com corte Laser

T8		F8	T8	D740490ZB	F8	D740479ZB	HSS	0	0	12	48	4	2	6	0 / 0	MATRIX PRO MATRIX EVO MATRIX SLX MATRIX SX MATRIX S
T8		F8W	T8	D740490ZB	F8W	D740480ZB		0	0	12	48	4	2	6	0 / 0	
T11		F11	T11	D740337ZB	F11	D740404ZB	HSS	0	0	5	48	2,5	2	6	0 / 0	
T11/L		F11/L	T11/L	D740839ZB	F11/L	D740838ZB	HSS	0	0	6	48	2,5	2	6	0 / 0	
T22		F22	T22	D739974ZB	F22	D739973ZB	HSS	0	0	6	48	2,5	2	6	0 / 0	
T22		F22W	T22	D739974ZB	F22W	D740423ZB		0	0	6	48	2,5	3	6	0 / 0	
T23		F23	T23	D740352ZB	F23	D740424ZB	HSS	0	0	5	48	1,5	2	6	0 / 0	
T30		F30	T30	D740360ZB	F30	D740434ZB	HSS	0	0	6	48	3	2	6	0 / 0	
T30		F30W	T30	D740360ZB	F30W	D740435ZB		0	0	6	48	3	3	6	0 / 0	

Cutters and Tracer points for Mechanic Key Cutting Machines

Fresini e Tastatori per Duplicatrici Meccaniche / Fräser und Taster für Mechanische Schlüsselkopiermaschine / Fraises et Palpeurs pour Machines Mécaniques
Fresas y Palpadores para Duplicadoras Mecánicas / Fresas e Palpadores para Duplicadoras Mecânicas

Tracer point		Cutters / Fresini / Fräser / Fraises / Fresas / Fresas											Key Cutting Machines Duplicatrici Schlüsselkopiermaschinen Machines à tailler les clés Duplicadoras Duplicadoras
Model Modello Modell Modelo Modelo	Code Codice Kode Code Código	Model Modello Modell Modelo Modelo	Code Codice Kode Code Código	 HSS	$\emptyset A$ (mm)	α 	T (mm)	L (mm)	$\emptyset t$ (mm)	No. of Cuttings	$\emptyset G$ (mm)	$\emptyset B$ $\emptyset C$ (mm)	

Laser Cutters

Fresini per Chiavi Laser / Fräser für Bahnen-Schlüsseln / Fraisers pour Clés à taillage Laser / Fresas para Llaves de Regata / Fresar para Chaves com corte Laser

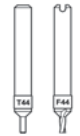
	T44	D740372ZB	F44	D740448ZB	HSS	0	0	6	48	2	2	6	0 / 0	MATRIX PRO MATRIX EVO MATRIX SLX MATRIX SX MATRIX S
---	------------	------------------	------------	------------------	-----	---	---	---	----	---	---	---	-------	---

Special Cutters

Frese Speciali / Spezialfräser / Fraises Spéciales / Fresas Especiales / Fresas Especiais

	T3	D740359ZB	F3	D740433ZB	HSS	0	90	0,9	48	1,5	2	6	0 / 0	MATRIX PRO MATRIX EVO MATRIX SLX MATRIX SX MATRIX S
	T3	D740359ZB	F3W	D740443ZB		0	90	0,9	48	1,5	2	6	0 / 0	
	T9	D740489ZB	F9	D740481ZB	HSS	0	(*)	6	48	3,5	1	6	0 / 0	
	T10	D740336ZB	F10	D740403ZB	HSS	10	(*)	1	48	0	0	6	0 / 0	
	T12A	D740339ZB	F12A	D740406ZB	HSS	0	(*)	0	48	0,6	1	6	0 / 0	
	T12A	D740339ZB	F12AW	D740407ZB		0	(*)	0	48	0,6	2	6	0 / 0	
	T12B	D740340ZB	F12B	D740408ZB	HSS	0	(*)	0	48	0	2	6	8 / 2,8	

(*) Special angle cutter / Fresino con angoli speciali / Fräser mit speziellen Winkeln / Fraise à angles spéciaux / Fresa con ángulos especiales / Fresa com ângulos especiais

Cutters and Tracer points for Mechanic Key Cutting Machines













Fresini e Tastatori per Duplicatrici Meccaniche / Fräser und Taster für Mechanische Schlüsselkopiermaschine / Fraises et Palpeurs pour Machines Mécaniques
Fresas y Palpadres para Duplicadoras Mecánicas / Fresas e Palpadres para Duplicadoras Mecânicas

Tracer point		Cutters / Fresini / Fräser / Fraises / Fresas / Fresas											Key Cutting Machines Duplicatrici Schlüsselkopiermaschinen Machines à taller les clés Duplicadoras Duplicadoras		
Model Modello Modell Modelo Modelo	Code Codice Kode Code Código	Model Modello Modell Modelo Modelo	Code Codice Kode Code Código	HSS	α (mm)	α°	T (mm)	L (mm)	ϕ_t (mm)	No. of Cuttings	ϕ_G (mm)	ϕ_B ϕ_C (mm)			
Special Cutters Frese Speciali / Spezialfräser / Fraises Spéciales / Fresas Especiales / Fresas Especiais															
T12B 	F12BW	T12B	D740340ZB	F12BW	D740409ZB		0	(*)	0	48	0	2	6	8 / 2,8	MATRIX PRO MATRIX EVO MATRIX SLX MATRIX SX MATRIX S
T15 	F15	T15	D740344ZB	F15	D740412ZB	HSS	0	(*)	10	48	0,8	1	6	0 / 8	
T17 	F17	T17	D740346ZB	F17	D740415ZB	HSS	10	(*)	0,8	48	0	0	6	0 / 0	
T19 	F19	T19	D740348ZB	F19	D740417ZB	HSS	0	(*)	5	48	0,6	1	6	0 / 2,2	
T21 	F21	T21	D740350ZB	F21	D740421ZB	HSS	0	(*)	5	48	0,8	1	6	0 / 3,2	
T25 	F25W	T25	D740354ZB	F25W	D740427ZB		0	(*)	10	48	0,65	2	6	0 / 3,5	
T27 	F27	T27	D740356ZB	F27	D740429ZB	HSS	0	(*)	0	48	0	1	6	24 / 1,9	
T29 	F29	T29	D740358ZB	F29	D740431ZB	HSS	0	(*)	0,3	48	0,76	1	6	0 / 1,9	
	F31	-	-	F31	D740436ZB	HSS	0	(*)	5,5	39	0,38	2	6	0 / 9,7	

(*) Special angle cutter / Fresino con angoli speciali / Fräser mit speziellen Winkeln / Fraise à angles spéciaux / Fresa con ángulos especiales / Fresa com ângulos especiais

Cutters and Tracer points for Mechanic Key Cutting Machines

Fresini e Tastatori per Duplicatrici Meccaniche / Fräser und Taster für Mechanische Schlüsselkopiermaschine / Fraises et Palpeurs pour Machines Mécaniques
Fresas y Palpadores para Duplicadoras Mecánicas / Fresas e Palpadores para Duplicadoras Mecânicas

Tracer point		Cutters / Fresini / Fräser / Fraises / Fresas / Fresas												Key Cutting Machines Duplicatrici Schlüsselkopiermaschinen Machines à tailler les clés Duplicadoras Duplicadoras		
Model Modello Modell Modelo Modelo	Code Codice Code Código Código	Model Modello Modell Modelo Modelo	Code Codice Code Código Código	 HSS	$\emptyset A$ (mm)	α 	T (mm)	L (mm)	$\emptyset t$ (mm)	No. of Cuttings	$\emptyset G$ (mm)	$\emptyset B$ $\emptyset C$ (mm)				
Special Cutters Frese Speciali / Spezialfräser / Fraises Spéciales / Fresas Especiales / Fresas Especiais																
T37		F37	T37	D740365ZB	F37	D740440ZB	HSS	0	(*)	0	48	0	2	6	6 / 2,1	MATRIX PRO MATRIX EVO MATRIX SLX MATRIX SX MATRIX S
T38		F38	T38	D740366ZB	F38	D740441ZB	HSS	0	(*)	0	48	0	2	6	6 / 3,3	
T40		F40	T40	D740369ZB	F40	D740445ZB	HSS	0	(*)	10	48	0,4	1	6	0 / 8	
T43		F43	T43	D740371ZB	F43	D740447ZB	HSS	0	(*)	6	48	1	1	6	0 / 2,2	
T51		F51	T51	D740380ZB	F51	D740457ZB		0	(*)	10	48	0,72	2	6	0 / 8,5	
T52		F52	T52	D740381ZB	F52	D740458ZB	HSS	0	(*)	0	48	0,86	2	6	2 / 1	
T54		F54	T54	D740383ZB	F54	D740459ZB	HSS	0	(*)	0	48	4	6	6	3 / 0	
T54		F54W	T54	D740383ZB	F54W	D740460ZB		0	(*)	0	48	4	4	6	3 / 0	
T56		F56	T56	D740385ZB	F56	D740462ZB	HSS	0	(*)	10	48	0,72	2	6	0 / 8,5	

(*) Special angle cutter / Fresino con angoli speciali / Fräser mit speziellen Winkeln / Fraise à angles spéciaux / Fresa con ángulos especiales / Fresa com ângulos especiais

Cutters and Tracer points for Mechanic Key Cutting Machines

Fresini e Tastatori per Duplicatrici Meccaniche / Fräser und Taster für Mechanische Schlüsselkopiermaschine / Fraises et Palpeurs pour Machines Mécaniques
Fresas y Palpadores para Duplicadoras Mecánicas / Fresas e Palpadores para Duplicadoras Mecânicas

Tracer point		Cutters / Fresini / Fräser / Fraises / Fresas / Fresas											Key Cutting Machines Duplicatrici Schlüsselkopiermaschinen Machines à tailler les clés Duplicadoras Duplicadoras
Model Modello Modell Modèle Modelo	Code Codice Kode Code Código	Model Modello Modell Modèle Modelo	Code Codice Kode Code Código	HSS	$\emptyset A$ (mm)	α° 	T (mm)	L (mm)	$\emptyset t$ (mm)	No. of Cuttings	$\emptyset G$ (mm)	$\emptyset B$ $\emptyset C$ (mm)	

Special Cutters

Frese Speciali / Spezialfräser / Fraises Spéciales / Fresas Especiales / Fresas Especiais

T57		F57W	T57	D740386ZB	F57W	D740463ZB		0	(*)	0	48	0,8	2	6	0 / 2,8	MATRIX PRO MATRIX EVO MATRIX SLX MATRIX SX MATRIX S
T58		F58W	T58	D740387ZB	F58W	D740464ZB		0	90	7	48	0	2	6	2,5 / 1,65	
T62		F62W	T62	D740391ZB	F62W	D740469ZB		11,8	(*)	1	48	0	0	6	0 / 0	
T63		F63	T63	D740954ZB	F63	D740952ZB	HSS	0	(*)	3,5	48	0,5	2	6	0 / 0	
T65		F65	T65	D740394ZB	F65	D740471ZB	HSS	0	(*)	6	48	1,05	2	6	0 / 3,8	
T68		F68	T68	D740397ZB	F68	D740474ZB	HSS	0	(*)	5	48	2,2	3	6	0 / 3	
-	-	-	-	D700077ZB	-	-	HSS	0	0	10	40	5,95	4	6	0 / 0	CROWN OPERA III OPERA IV
-	-	-	-	D704541ZB	-	-	HSS	0	0	13	40	3	3	6	0 / 0	CROWN (T14) OPERA III (T14)
-	-	-	-	D705407ZB	-	-	HSS	0	0	13	40	2,5	3	6	0 / 0	CROWN (T15) OPERA III (T15)
-	-	-	-	D710596ZB	-	-	HSS	0	0	10	52	5,95	4	6	0 / 0	OPERA III OPERA III SK

(*) Special angle cutter / Fresino con angoli speciali / Fräser mit speziellen Winkeln / Fraise à angles spéciaux / Fresa con ángulos especiales / Fresa com ângulos especiais

Trade Marks

Marchi Registrati / Registrierte Handelsmarken / Marques Déposées / Marcas Registradas / Marcas Registradas

ENGLISH

In compliance with current regulations relating to industrial property, we hereby state that the trade-marks or trade names mentioned in this document are the exclusive property of authorized manufacturers of locks and users. Said trade-marks or trade names are nominated only for the purposes of information so that any lock for which our keys are made can be rapidly identified. This document is reserved exclusively for professional key cutters who use Silca products. All information and illustrations in this document are for guidance only. Silca reserves the right to alter products designs, dimensions or info to improve the products quality. The contents of this document are fully protected by Copyright and may not be copied or reproduced in any form, without written permission from Silca S.p.A. Any controversy shall be settled by the Courts of Justice where the company has its headquarters, with express exclusion of any other court.

ITALIANO

In conformità alle disposizioni legali in vigore relative alle proprietà industriali, informiamo che i marchi o le denominazioni commerciali citate nel nostro documento sono di proprietà esclusiva dei Fabbricanti di Serrature e degli utilizzatori autorizzati. Questi marchi o denominazioni commerciali sono indicati a titolo di semplice informazione, con lo scopo di riconoscere velocemente a quali serrature le nostre chiavi sono destinate. Questo documento è esclusivamente riservato ai professionisti della riproduzione chiavi che utilizzano i prodotti Silca. Le illustrazioni e i dati tecnici dei prodotti contenuti nel documento debbono considerarsi indicativi. Silca si riserva il diritto, ferme restando le caratteristiche essenziali dei prodotti, di apportare tutte le modifiche che ritiene necessarie e opportune al fine di migliorare la qualità dei prodotti. Tutti i disegni e le fotografie sono di proprietà di Silca, ogni riproduzione anche parziale, senza autorizzazione scritta di Silca S.p.A. è vietata secondo termini di legge. Per qualsiasi controversia competenti sono gli Uffici Giudiziari dove ha sede l'Azienda, con espressa esclusione di qualsiasi altro foro.

DEUTSCH

Gemäß den derzeit geltenden Normen bezüglich des Industrieigentums teilen wir Ihnen mit, dass die in der vorliegenden Broschüre angeführten Markennamen oder Handelsmarken ausschließliches Eigentum der Schlosshersteller und zugelassenen Fachhändler sind. Diese Markenbezeichnungen oder Handelsmarken sind nur zur Information angeführt, mit dem Zweck, schnell erkennen zu können, zu welchem Schloss unsere Schlüssel gehören. Die vorliegende Broschüre ist ausschließlich an Fachgeschäfte gerichtet, die Silca Produkte einsetzen. / Die Abbildungen und technischen Daten in dieser Broschüre sind nur zur Information. Silca behält sich vor, etwaige Änderungen, die zur Verbesserung des Produktes beitragen, vorzunehmen. Alle Zeichnungen und Fotos sind Eigentum der Firma Silca. Jede Reproduktion, auch teilweise, ist ohne ausdrückliche Genehmigung der Silca S.p.A. gesetzlich untersagt. Im Falle von Streitfragen ist der Gerichtsstand des Firmensitzes zuständig; jeder andere Gerichtsstand ist ausgeschlossen.

FRANÇAIS

Conformément aux lois en vigueur concernant la propriété industrielle, nous vous informons que les marques et appellations commerciales citées dans notre documentation appartiennent exclusivement aux fabricants de serrures et aux utilisateurs autorisés. Ces marques ou appellations commerciales sont indiquées à titre d'information pure et simple pour vous permettre de déterminer rapidement les serrures auxquelles nos clés sont destinées. Cette documentation est réservée exclusivement aux professionnels du taillage de clés qui utilisent les produits Silca. Les illustrations et les caractéristiques techniques des produits présentés dans cette documentation sont données à titre indicatif. Bien que les caractéristiques essentielles des produits soient invariables, Silca se réserve le droit d'apporter toutes les modifications qu'elle retiendra nécessaires et opportunes afin d'améliorer la qualité de ses produits. Tous les dessins et photos sont propriété Silca et toute reproduction, même partielle, sans l'autorisation écrite préalable de Silca S.p.A. est interdite conformément aux prescriptions légales. Tout litige est du ressort exclusif des Tribunaux de la circonscription où se trouve le Siège de la Société.

ESPAÑOL

En conformidad con las disposiciones legales vigentes sobre la Propiedad Industrial, las marcas y denominaciones comerciales citadas en nuestra documentación se declaran propiedad exclusiva de los fabricantes de cerraduras y los usuarios autorizados. Dichas marcas o denominaciones comerciales se citan con mero carácter informativo, con objeto de hacer comprender sin dificultad a qué cerraduras van destinadas nuestras llaves. Esta documentación está reservada exclusivamente a los profesionales de la duplicación de llaves que utilizan los productos Silca. / Las ilustraciones y los datos técnicos de los productos en esta documentación son indicativos. Silca se reserva el derecho, quedando invariables las características principales de los productos, de modificar todo lo que considere necesario y oportuno para mejorar la calidad de sus artículos. Todos los dibujos y fotografías pertenecen a Silca; según determina la Ley, se prohíbe toda reproducción, total o parcial, sin autorización por escrito de Silca S.p.A. En caso de disconformidad, la competencia es de las autoridades judiciales donde esté domiciliada la firma, excluyendo cualquier otro Tribunal.

PORTUGÜES

Em conformidade com as disposições legais em vigor relativas à propriedade industrial, informamos que as marcas ou as denominações comerciais citadas na nossa documentação são propriedade exclusiva dos fabricantes de fechaduras e dos utilizadores autorizados. Estas marcas ou denominações comerciais são indicadas só a nível de informação, a fim de reconhecer rapidamente a quais fechaduras se destinam as nossas chaves. Esta documentação é reservada exclusivamente aos profissionais da reprodução de chaves que utilizam os produtos Silca. / As ilustrações e as características técnicas dos produtos apresentados nesta documentação são facultados a título indicativo. Mesmo que as características essenciais dos produtos sejam invariáveis, à Silca reserva-se o direito de modificar ser necessário e oportuno los productos, afim de melhorar a sua qualidade. Todos os desenhos e fotos são propriedade da Silca, e é proibida a sua reprodução mesmo parcial sem a autorização escrita da Silca S.p.A. conforme as prescrições legais. Em caso de litígio fica desde já designado, excluindo qualquer outro, o Tribunal da comarca onde está registada a sede da Silca.

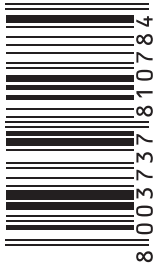

P032
Printed in Italy 02/2013

SILCA S.p.A.
Via Podgora, 20 (Z.I.)
31029 VITTORIO VENETO (TV)
Phone: +39 0438 9136
Fax +39 0438 913800
E-mail: silca@silca.it
www.silca.biz



SILCA S.A.S.
12, Rue de Rouen
Z.I. Limay - Porcheville
78440 PORCHEVILLE
Phone: +33 1 30983500
Fax +33 1 30983501
E-mail: info@silca.fr
www.silca.fr

SILCA GmbH
Siemensstrasse, 33
42551 VELBERT
Phone: +49 2051 2710
Fax +49 2051 271172
E-mail: info@silca.de
www.silca.de

SILCA KEY SYSTEMS S.A.
C/Santander 73A
08020 BARCELONA
Phone: +34 93 4981400
Fax +34 93 2788004
E-mail: silca@silca.es
www.silca.es

SILCA Ltd.
Unit 6 Lloyds Court
Manor Royal
CRAWLEY RH10 9QU
Phone: +44 1293 531134
Fax +44 1293 531108
E-mail: sales@silcald.co.uk
www.silcald.co.uk

MINDA SILCA Engineering Ltd.
Plot no. 37- Toy City
Greater Noida-201308, U.P.
Phone: +91 9871397630/31
Fax +91 120 2351301
E-mail: info@mindasilca.in
www.mindasilca.in

H. CILLEKENS & ZN. B.V.
Metaalweg, 4
6045 JB ROERMOND
Phone: +31 475 325147
Fax +31 475 323640
E-mail: info@hcillekens.nl
www.hcillekens.nl

KABA DO BRASIL Ltda
Rua Guilherme Asbahr Neto, 510
São Paulo, SP 04646-001
Phone: +55 11 55454520 / 29
E-mail: silca@kabadobrasil.com.br
www.silcabrasil.com.br

Members of the Kaba Group

